

ALEXA 35

Software Update Package 1.2.1

USER MANUAL

December 18, 2023



Disclaimer

Before using the products, be sure to read and understand all respective instructions.

The products are available for commercial customers only.

For product specification changes since this manual was published, refer to the latest publications of ARRI data sheets or data books, etc., for the most up-to-date specifications. Not all products and/or types are available in every country. Please check with an ARRI sales representative for availability and additional information.

ARRI assumes no responsibility for any errors that may appear in this document. The information is subject to change without notice.

While ARRI endeavors to enhance the quality, reliability and safety of their products, customers agree and acknowledge that the possibility of defects thereof cannot be eliminated entirely. To minimize risk of damage to property or injury (including death) to persons arising from defects in the products, customers must incorporate sufficient safety measures in their work with the system and have to heed the stated canonic use.

ARRI or its subsidiaries expressly exclude any liability, warranty, demand or other obligation for any claim, representation, or cause, or action, or whatsoever, express or implied, whether in contract or tort, including negligence, or incorporated in terms and conditions, whether by statute, law or otherwise. In no event shall ARRI or its subsidiaries be liable for or have a remedy for recovery of any special, direct, indirect, incidental, or consequential damages, including, but not limited to lost profits, lost savings, lost revenues or economic loss of any kind or for any claim by third party, downtime, good will, damage to or replacement of equipment or property, any cost or recovering of any material or goods associated with the assembly or use of our products, or any other damages or injury of the persons and so on or under any other legal theory.

Neither ARRI nor its subsidiaries assume any liability for infringement of patents, copyrights or other intellectual property rights of third parties by or arising from the use of ARRI products or any other liability arising from the use of such products. No license, express, implied or otherwise, is granted under any patents, copyrights or other intellectual property right of ARRI or others.

ARRI or its subsidiaries do not assume any responsibility for incurred losses due to improper handling or configuration of the camera or other system components, due to sensor contamination, occurrence of dead or defective pixels, defective signal connections or incompatibilities with third party recording devices.

In the case one or all of the foregoing clauses are not allowed by applicable law, the fullest extent permissible clauses by applicable law are validated.

Imprint

© 2023 Arnold & Richter Cine Technik GmbH & Co. Betriebs KG. All rights reserved.

The system contains proprietary information of Arnold & Richter Cine Technik GmbH & Co. Betriebs KG. It is provided under a license agreement containing restrictions on use and disclosure and protected by copyright law. Reverse engineering of the software is prohibited.

No part of this publication may be reproduced, stored in a retrieval system, or transmitted in any form or by any means, electronic, mechanical, photocopying, recording or otherwise without the prior written permission of Arnold & Richter Cine Technik GmbH & Co. Betriebs KG.

Due to continued product development the information in this document may change without notice. The information and intellectual property contained herein is confidential between ARRI and the client and remains the exclusive property of ARRI. If you find any problems in the documentation, please report them to us in writing. ARRI does not warrant that this document is flawless.

ARRI, ALEXA 35 and ARRIRAW are trademarks or registered trademarks of Arnold & Richter Cine Technik GmbH & Co. Betriebs KG. All other brands or products mentioned are trademarks or registered trademarks of their respective holders and should be treated as such.



Apple ProRes 422 HQ, Apple ProRes 4444, Apple ProRes 4444 XQ, and the ProRes logo are trademarks or registered trademarks of Apple Computer, Inc., used under license therefrom.

Original version.

For Further Assistance

Arnold & Richter Cine Technik GmbH & Co. Betriebs KG
Herbert-Bayer-Str. 10
80807 Munich
Germany

service@arri.com

www.arri.com/en/technical-service

1 Contents

- 1 Contents.....4**
- 2 About this Document..... 7**
- 3 Camera Body Overview..... 8**
- 4 Multi Viewfinder MVF-2 Overview..... 14**
- 5 Camera Control Monitor CCM-1 Overview..... 18**
- 6 Power Supply..... 20**
- 7 Menu Operation.....23**
 - 7.1 HOME Screen.....24
 - 7.2 Working with Settings/Lists and Importing Files.....26
 - 7.3 On-screen Keyboard.....28
 - 7.4 Side Display..... 28
 - 7.5 User Storage.....29
 - 7.6 Info Screens.....31
- 8 Status Information and Overlays..... 33**
- 9 Main Parameters..... 37**
 - 9.1 Project Settings.....37
 - 9.2 Sensor Frame Rate..... 38
 - 9.3 Shutter.....38
 - 9.4 Exposure Index.....40
 - 9.5 ND Filter.....41
 - 9.6 White Balance.....41
 - 9.7 Timecode.....42
- 10 Look Settings..... 44**
 - 10.1 Color Processing and Color Space.....44
 - 10.2 Look File ALF4..... 47
 - 10.3 Setting the Look.....48
 - 10.4 Look Intensity.....49
- 11 ARRI Textures..... 50**
- 12 Recording.....53**
 - 12.1 Recording Medium.....53
 - 12.2 Recording Codec..... 56
 - 12.3 Sensor Mode & Recording Resolution..... 57
 - 12.4 Starting Recording..... 60
 - 12.5 Prerecording.....60
 - 12.6 Clip Naming Scheme.....63

- 12.7 Audio Recording..... 64
- 12.8 Rec Beeper and Tally..... 67
- 13 Playback..... 68**
- 14 Monitoring..... 70**
- 14.1 Surround View..... 70
- 14.2 Magnification..... 71
- 14.3 Frame Lines..... 72
- 14.4 False Color..... 75
- 14.5 Peaking..... 76
- 14.6 Zoom..... 77
- 14.7 SDI Settings..... 78
- 14.8 EVF and Flip-out Monitor Settings..... 80
- 14.9 Return In..... 81
- 14.10 SDI Color Bars..... 81
- 15 User Buttons..... 82**
- 16 Synchronization..... 85**
- 17 Sensor Settings..... 86**
- 17.1 Mirroring the Sensor Image..... 86
- 17.2 User Pixel Masking..... 86
- 18 System Settings..... 88**
- 18.1 Language Setting..... 88
- 18.2 System Time and Date..... 88
- 18.3 Button and Display Settings..... 88
- 18.4 Fan Settings..... 88
- 18.5 Reset of Electronic Horizon..... 88
- 18.6 Update..... 89
- 18.6.1 Update of Camera Software..... 89
- 18.6.2 Update of Camera Components..... 89
- 18.6.3 Update of LBUS Devices..... 90
- 18.6.4 Update of Codex Compact Drive..... 90
- 18.6.5 Update of PDM-1..... 90
- 19 User Setups..... 91**
- 19.1 User Setup Parameter Blocks..... 92
- 20 Network..... 93**
- 20.1 WiFi Settings..... 93
- 20.2 Ethernet Settings..... 95
- 20.3 Streaming Metadata..... 95

21	Metadata.....	97
22	Lens & Electronic Control System (ECS).....	98
22.1	Lens Data.....	98
22.2	Lens Data Archive.....	99
22.3	White Radio Configuration.....	100
22.4	Lens Motors.....	102
22.5	Changing a Lens.....	103
22.6	EF Lens Iris Adjustment.....	104
22.7	Enable Lens Mount.....	105
23	Remote Control.....	106
23.1	Web Remote.....	106
23.2	Camera Access Protocol (CAP).....	107
23.3	Camera Companion App.....	108
23.4	Hand Units Hi-5 and WCU-4.....	108
24	ALEXA 35 Accessories.....	109
24.1	Lens Mounts.....	109
24.1.1	Changing the Lens Mount.....	110
24.2	Mechanical Accessories.....	112
24.2.1	Bottom Accessories.....	112
24.2.2	Top Accessories.....	114
24.2.3	Side Accessories.....	117
24.2.4	Other Accessories.....	118
24.3	Electronic Accessories.....	119
24.4	Battery Adapters.....	120
25	Appendix.....	122
25.1	Data Rates, Recording Times and Max. FPS.....	122
25.2	Sensor Related Information.....	124
25.3	Companion Tools.....	125
25.4	Connector Pin-Outs.....	126
25.5	Dimensional Drawings.....	128

2 About this Document

This user manual is aimed at everyone involved in using the system and provides directions on how to operate it safely and as intended.

To ensure safe and correct use, all users need to read the ALEXA 35 Operating Manual before using the system for the first time. It contains detailed information on how to use the system safely.

This user manual is an essential part of the product and should be easily accessible and in proximity to the equipment so that users can use it as a reference anytime.

Keep the ALEXA 35 User Manual, the ALEXA 35 Operating Manual and all other instructions belonging to the system in a safe place for future reference and possible subsequent owners.

Document Revision History

Document ID: D45 10006703

Version	Release	Date	Description
1.0	K10948	July 18, 2022	Initial Release
1.1	K11240	May 2, 2023	Release for SUP 1.1
1.2	K11289	July 24, 2023	Release for SUP 1.2
1.2.1	K11380	December 18, 2023	Release for SUP 1.2.1

How To Use This Manual

All directions are given from a camera operator's point of view. For example, camera right side refers to the right side of the camera when standing behind the camera and operating it in a normal fashion.

Connectors are written in all capital letters, for example "AUDIO connector".

Buttons are written in italic typeface capital letters, for example "*PLAY* button".

Menu paths are written in italic typeface, with menu and home in capital letters, for example "*MENU > Recording > Sensor Mode*".

"EVF" refers to the OLED eyepiece of the MVF-2 viewfinder.

"Monitor" refers to the flip-out monitor of the MVF-2 viewfinder.

"VF" refers to the viewfinder connectors VF 1 and VF 2. When settings refer to VF, they affect the EVF and the flip-out monitor.

"Monitoring outputs" refers to EVF, flip-out monitor, SDI 1 and SDI 2.

"Status Info" refers collectively to the Status Info of EVF, SDI 1 and SDI 2.

Strengthen Your Knowledge and Get Trained

The ARRI Academy courses provide unrivaled insights into the full possibilities of working with ARRI camera systems, lenses, lights and accessories.

To learn more, please visit <http://arri.com/academy>.

3 Camera Body Overview

Camera Front

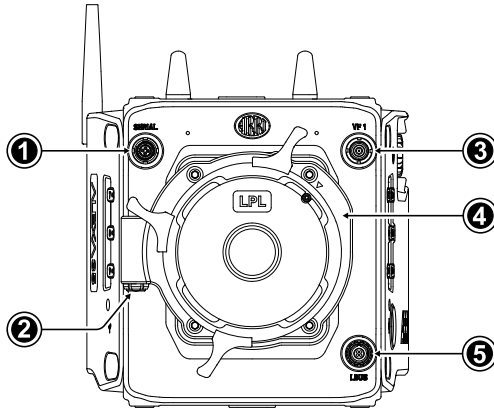

- 1 SERIAL Connector
- 2 LBUS Connector (on Lens Mount)
- 3 VF 1 Viewfinder Connector
- 4 Lens Mount (here: LPL Mount (LBUS))
- 5 LBUS Connector

SERIAL Connector (4-pin LEMO)

The SERIAL connector is used to connect distance measurement devices such as ARRI UDM-1, CE CineTape Measure or Focus Bug directly to the camera and receives data from and provides power to the distance measuring device. The SERIAL connector outputs regulated 12.0 V with a maximum current of 200 mA.

VF 1 Viewfinder Connector (CoaXPress)

The camera uses industrial CoaXPress interfaces with a custom ARRI connector to connect the MVF-2 viewfinder and the Camera Control Monitor CCM-1 with the camera. The interface transmits power, video and control data and supports cable lengths of up to 10 m (33 ft). The VF connector comes without a key, so the VF cables plug in regardless of their orientation.

LBUS Connector (4-pin LEMO)

Both LBUS connectors are used to connect daisy chainable LBUS devices of the ECS Electronic Control System (lens motors, ARRI Master Grips, ARRI OCU-1, RIA-1...) to the camera and supply regulated 24.0 V with a maximum current of 4.0 A.

ADVICE



Do not connect both LBUS ports (body and lens mount) of the ALEXA 35 in a daisy chain and thus form a loop, you may experience problems such as the camera shutting down.

Camera Left

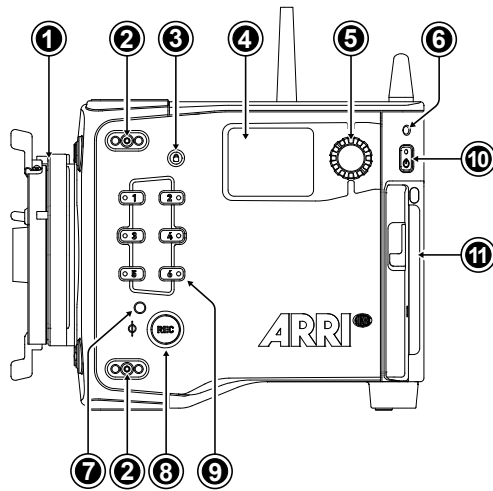

- 1 Lens Mount (here: LPL Mount (LBUS))
- 2 Mounting Points for Accessories
- 3 LOCK Button
- 4 Side Display
- 5 Side Display Jogwheel
- 6 Rear Camera Status LED
- 7 Left Camera Status LED
- 8 REC Button
- 9 User Buttons 1-6
- 10 POWER Button
- 11 Camera Identification Label

REC Button, LOCK Button & User Buttons 1-6

Use the REC button (8) to start and stop recording. Press and hold the LOCK button (3) to lock all camera buttons. Besides the REC and LOCK button, the camera left is equipped with six freely assignable user buttons (9). Each button can be customized with individual functions. Once a user button is assigned with a function, press the button to trigger its function. An LED on each user button reflects the functional status.

Camera Status LEDs

The camera status LEDs reflect the current camera state:

Off	Idle. No recording media inserted or recording media full
Green	Standby and ready to record
Orange	Prerecording
Red	Recording
Red / Green flashing	Error State

Side Display and Jogwheel

The side display provides control of basic camera parameters, recording media erase and can show general information on the camera status. Use the jogwheel to navigate through screens and change settings.

Media Door and Media Door Release

To access the media slot, slide the media door release towards the camera bottom so that the spring loaded door jumps open.

Camera Identification Label

The camera serial number is located on the left side of the camera next to the media bay door. The serial number consists of the last 5 digits of the product number K1.0039373-XXXXX.

Camera Right

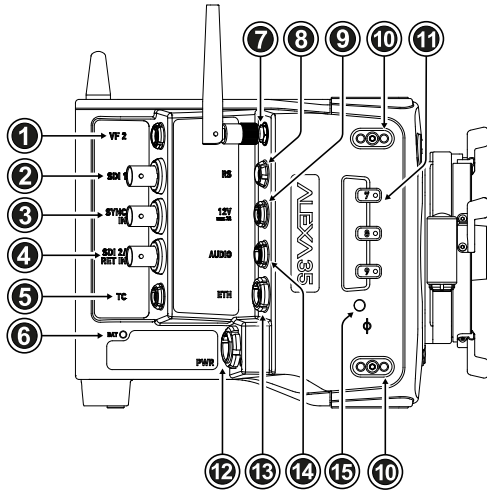

- 1 VF 2 Viewfinder Connector
- 2 SDI 1 Connector
- 3 SYNC IN Connector
- 4 SDI 2 / RET IN Connector
- 5 TC (Timecode) Connector
- 6 BAT LED
- 7 ECS White Radio Antenna Connector
- 8 RS Connector
- 9 12V Connector
- 10 Mounting Points for Accessories
- 11 User Buttons 7-9
- 12 PWR Connector
- 13 ETH Connector
- 14 AUDIO Connector
- 15 Right Camera Status LED

VF 2 Viewfinder Connector (CoaXPress)

VF 2 is the second viewfinder port. The camera uses industrial CoaXPress interfaces with a custom ARRI connector to connect the MVF-2 viewfinder and the Camera Control Monitor CCM-1 with the camera. The interface transmits power, video and control data and supports cable lengths of up to 10 m (33 ft). The VF connector comes without a key, so the VF cables plug in regardless of their orientation.

SDI 1 & SDI 2 / RET IN (BNC)

Both SDI BNC connectors can be configured to output the following video signals:

- 422 1.5G HD (23.976, 24, 25, 29.97 and 30 fps progressive or psf) according to SMPTE ST 292-1:2012
- 422 3G HD (48, 50, 59.94 and 60 fps progressive) according to SMPTE ST 425-1:2014
- 444 3G HD (23.976, 24, 25, 29.97 and 30 fps progressive) according to SMPTE ST 425-1:2014
- 422 6G UHD (23.976, 24, 25, 29.97 and 30 fps progressive) according to SMPTE ST 2081-10:2015
- 422 12G UHD (48, 50, 59.94 and 60 frames fps progressive) according to SMPTE ST 2082-10:2015
- 444 12G UHD (23.976, 24, 25, 29.97 and 30 fps progressive) according to SMPTE ST 2082-10:2015

The SDI 2 / RET IN connector can be configured in the camera menu to function either as SDI output or as a Return In input, accepting 1.5G and 3G SDI signals.

SYNC IN (BNC)

The SYNC IN connector is a BNC connector for input of reference signals and accepts analog black burst signals and tri-level HD signals for camera synchronization.

TC (5-pin LEMO)

The TC connector accepts and outputs LTC (Longitudinal Timecode) signals.

White Radio Antenna Connector (Female RP-SMA)

White radio allows for wireless lens control, lens data communication and remote control of camera functions using the hand units of the ARRI Electronic Control System.

RS (3-pin Fischer)

The RS connector outputs regulated 24 V accessory power and can supply external devices with a load of up to 3.0 A. Additionally, the RS connector outputs a shutter pulse signal and can be used to send a remote start/stop signal to the camera.

12V (2-pin LEMO)

The 12 V output with a 2-pin LEMO connector supplies accessories with regulated 12.0 V with a maximum current of 2.0 A.

PWR (8-pin LEMO)

The PWR connector is the main power input for the ALEXA 35 and accepts an input voltage range from 20.5 to 33.6 V DC. You can use power cables KC50-S (K2.75007.0) or KC50-SP-S (K2.0001275) to power the camera from an external source.

ETH (10-pin LEMO)

The ETH Ethernet connector is used for camera remote control, metadata streaming and service purposes. It supplies regulated 24 V with a current of 0.5 A. Use the ALEXA Ethernet Cable KC 153-S (K2.72021.0) to connect the camera to a standard RJ-45 Ethernet port.

AUDIO (6-pin LEMO)

The AUDIO connector is a 2-channel +24 dBu line level audio input with an additional regulated 12 V power output with a current of up to 0.5 A. Use the ALEXA Mini LF Audio connector with cable (K2.0023988) to connect audio sources.

PWR and BAT Status LEDs

The BAT LED indicates the status of the power source connected to the BAT interface on the back of the camera used for onboard batteries, the PWR LED indicates the status of the power source connected to the PWR connector.

User Buttons 7-9

The camera right is equipped with three freely assignable user buttons (11). Each button can be customized with individual functions. Once a user button is assigned with a function, press the button to trigger its function. An LED on each user button reflects the functional status.

Camera Rear

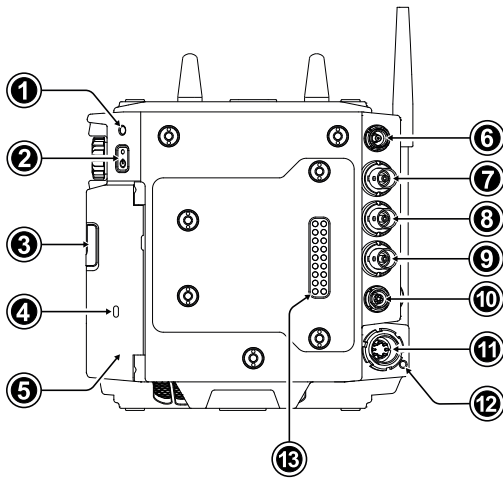

- 1 Rear Camera Status LED
- 2 POWER Button
- 3 Media Door Release
- 4 Media LED Window
- 5 Media Door
- 6 VF 2 Viewfinder Connector
- 7 SDI 1 Connector
- 8 SYNC IN Connector
- 9 SDI 2 / RET IN Connector
- 10 TC (Timecode) Connector
- 11 PWR Connector
- 12 PWR Status LED
- 13 Camera Rear Interface

POWER Button

Press the POWER button to switch the camera on, press and hold the button to switch the camera off.

Camera Rear Interface

The rear interface of the camera is used to connect battery adapter plates and electronic accessories such as the Power Distribution Module PDM-1 and the Audio Extension Module AEM-1. It supplies power, receives and transmits audio signals, time code and serial data. The power output to the rear interface pins is interrupted when no adapter or module is connected.

Camera Top

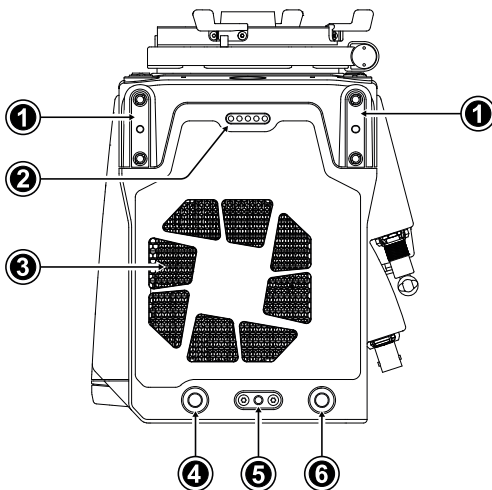

- 1 Mounting Points for Accessories
- 2 Top Connector
- 3 Fan Outlet
- 4 WiFi Antenna Connector
- 5 Mounting Point for Accessories
- 6 WiFi Antenna Connector

Top Connector

For future use.

WiFi Antenna Connectors (RP-SMA)

The camera is equipped with a 2.4 GHz WiFi module and two WiFi antennas, both located on the back of the camera.

Camera Bottom

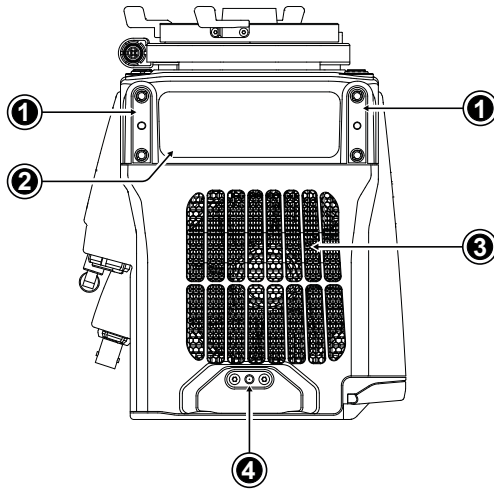

- 1 Mounting Points for Accessories
- 2 Conformity Label
- 3 Fan Intake
- 4 Mounting Point for Accessories

Media Bay

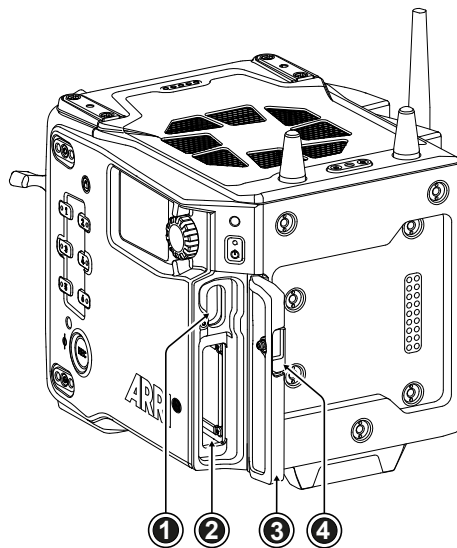

- 1 USB-C Connector
- 2 Recording Media Slot
- 3 Media Door
- 4 Media Door Release

Recording Media Slot

The camera records onto Codex Compact Drives, using the media bay on the camera left side. A small window in the media bay door shows the status LED of the Compact Drive. To access the media slot, slide the media door release (4) towards the camera bottom so that the spring loaded door jumps open.

USB-C Connector

The camera saves data such as user setups, frame grabs and log files to USB-C memory sticks formatted with exFAT file system. Software updates, additional frame lines and ARRI look files are loaded onto the camera from the USB-C memory stick. The USB-C connector (1) can also be used to charge USB devices and supplies 5.0 V with a maximum current of 1.5 A.

4 Multi Viewfinder MVF-2 Overview

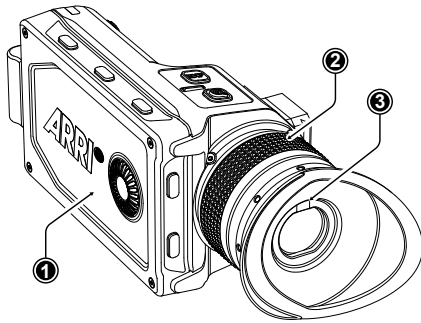

- 1 Flip-out Monitor
- 2 Diopter Adjustment
- 3 Proximity Sensor

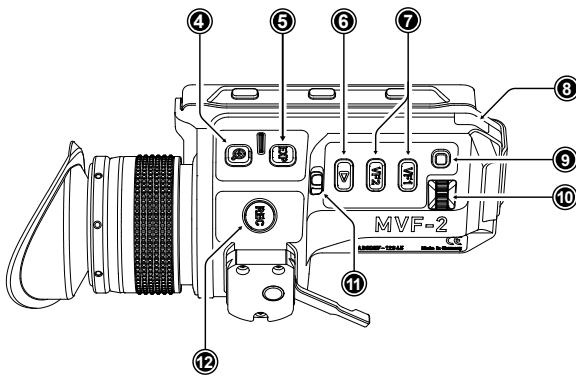

- 4 ZOOM Button
- 5 EXP Button
- 6 PLAY Button
- 7 VF 1&2 User Buttons
- 8 Top Tally Light
- 9 SET Button
- 10 User Wheel
- 11 LOCK Switch
- 12 REC Button

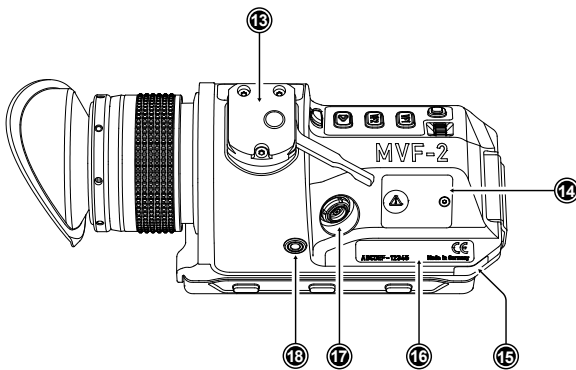

- 13 Dove Tail
- 14 Service Cover
- 15 Bottom Tally Light
- 16 Product Label
- 17 Viewfinder Connector
- 18 Headphones Out

EVF OLED Display

The MVF-2 is equipped with a high contrast, temperature controlled 1920 x 1080 OLED display.

Diopter Adjustment

With the camera switched on and while looking into the viewfinder, twist the ring (2) left or right to adapt the viewfinder image to your visual acuity. With the help of the scale labeled from 1 to 9 you can easily remember your adjustment when different people are using the viewfinder. The diopter adjustment can compensate from -5 to +5 diopters.

Proximity Sensor

This infrared sensor (3) automatically deactivates the MVF-2's internal OLED display when you withdraw your eye to prevent burn-ins on the panel and activates it again as soon as you approach the eyepiece. Do not permanently cover the sensor as this might cause irreversible burn-in on the OLED display.

ADVICE**Permanent Activation of the Viewfinder OLED Display**

Permanent activation can cause irreversible burn-ins on the viewfinder OLED display.

- ▶ Do not cover the viewfinder proximity sensor. When covered, the viewfinder OLED display will be switched on permanently.
- ▶ If you need to cover the viewfinder, disable the viewfinder OLED display first using the EVF Power setting.
- ▶ When shooting in hot environments, make sure to have the viewfinder mounted on the viewfinder bracket to ensure proper cooling.
- ▶ If the viewfinder is used as a remote control without standing support, turn off the viewfinder OLED display using the EVF Power setting.

Built-in Eyepiece Heater

The MVF-2 is equipped with a built-in eyepiece heater to prevent fogging of the eyepiece when shooting in cold environments. The eyepiece heater can be activated in the camera menu and only becomes active when the eyepiece has a temperature of 15 °C (59 °F) or below. In extremely cold environments please use the Heated Eyecup HE-7.

EXP Button

The *EXP* button (5) activates and deactivates the False Color exposure tool for the EVF and the flip-out monitor.

ZOOM Button

Pressing the *ZOOM* button (4) activates the zoom feature on EVF and the flip-out monitor for a temporary zoom-in to quickly check focus. The magnification ratio is 1:1, or one sensor photosite to one display pixel.

PLAY Button

Press and hold the *PLAY* button (6) for two seconds to start in-camera playback from the recording media.

VF 1 and VF 2 User Buttons

The MVF-2 has two user buttons, *VF1* and *VF2* (7). You can assign a frequently used function to each button.

SET Button and User Wheel

The *SET* button and the user wheel (9, 10) provide the same functionality as the jogwheel on the flip-out monitor (see next chapter) and can be used for menu navigation and adjustment when the flip-out monitor is used with the display visible in the folded-in position.

LOCK Switch

The *LOCK* switch (11) locks the touchscreen and all MVF-2 buttons. A dedicated lock icon is displayed on the HOME screen as well as in the Status Info of the EVF.

REC Button

The *REC* button (12) starts and stops recording to the recording media. With no recording media inserted, the button is inactive.

Product Label

The product label (16) shows the MVF-2 serial number. The serial number consists of the last 5 digits of the product number K1.0024074 - XXXXX.

Viewfinder Connector (CoaXPress)

The ALEXA 35 uses industrial CoaXPress interfaces with a custom ARRI connector to connect the MVF-2 viewfinder and the Camera Control Monitor CCM-1 with the camera. The interface transmits power, video and control data and supports cable lengths of up to 10 m (33 ft). The VF connector (17) comes without a key, so the VF cables plug in regardless of their orientation and support hot plugging of the viewfinder.

Headphones Out

The headphones out (18) is a 3.5 mm TRS connector (headphone jack), which outputs all four audio channels with a maximum power of 2.5 dBm.

Flip-out Touchscreen Monitor

The 4" flip-out touchscreen monitor with up and down tilt function displays the camera's live image or the main user interface (HOME screen and camera menu).

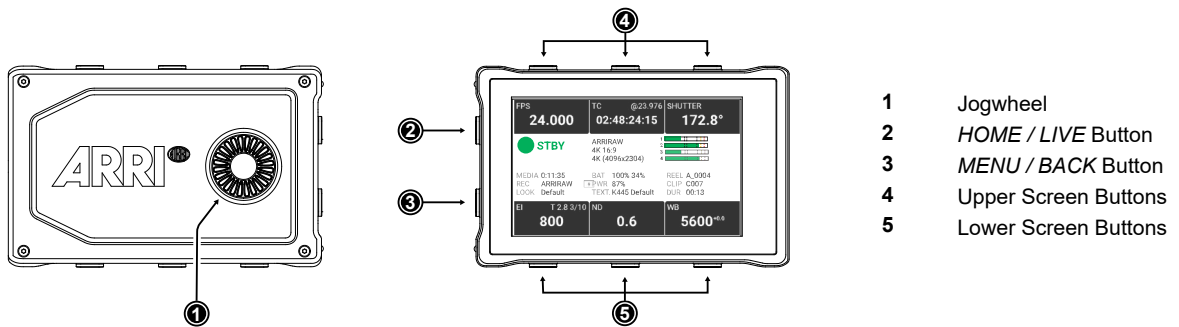

- 1 Jogwheel
- 2 HOME / LIVE Button
- 3 MENU / BACK Button
- 4 Upper Screen Buttons
- 5 Lower Screen Buttons

Jogwheel

The jogwheel (1) is used to

- ▶ Scroll or navigate through lists and menus
- ▶ Change values (by scrolling up or down)
- ▶ Access and confirm settings (by pressing the jogwheel center)

HOME / LIVE Button

The HOME / LIVE button (2) toggles to display either the HOME screen (shown in the image above) or the camera live view.

MENU / BACK Button

Pressing the MENU / BACK button (3) while in the HOME screen or in camera live view opens the camera menu. While in the camera menu, it serves as a BACK button.

Screen Buttons

The MVF-2 flip-out monitor has six screen buttons, three above (4) and three below (5) the screen. Their function depends on the screen content and is labeled directly below or above each button. Unlabeled buttons do not have a function for that screen. A grayed-out label indicates that the function is currently not available.

Adjusting the Flip-out Monitor

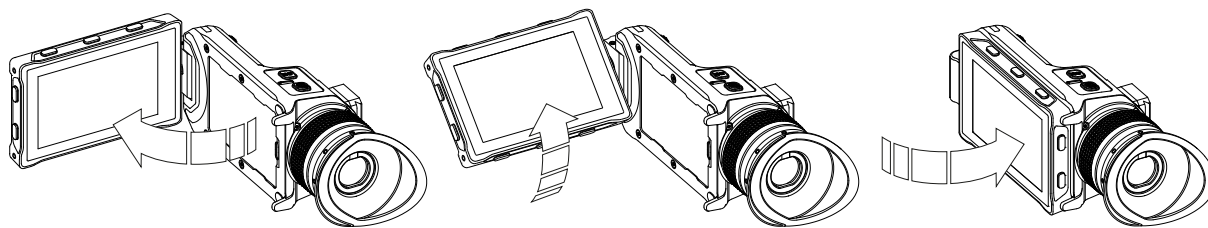

Fold out, swivel and fold in the monitor to put the display visible in the folded-in position. The image on the monitor automatically adjusts its orientation, or can be set to the desired orientation in the camera menu.

Viewfinder Cables

MVF-2 viewfinder cables are available in the following lengths:

ID No.	Length	Description
K2.0042857	0.5m (1.5 ft)	Standard cable with right angle connector
K2.0023944	2.0 m (6.5 ft)	The medium length for remote use (straight connector)
K2.0023945	10.0 m (33 ft)	The longest possible length for remote use (straight connector)

ADVICE

Although the camera is equipped with two viewfinder ports, two viewfinders cannot be operated in parallel. When two viewfinders are connected to the camera, the second connected viewfinder only displays a boot screen, but does not become active.

5 Camera Control Monitor CCM-1 Overview

The Camera Control Monitor CCM-1 is a 7" on board monitor that provides full camera control and menu access for the ALEXA Mini LF and the ALEXA 35.

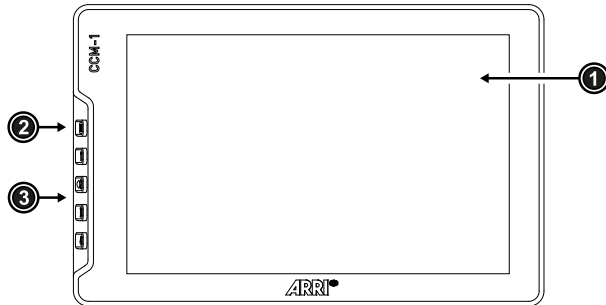

Front

- 1 Display
- 2 MENU Button
- 3 User Buttons

Display

The display (1) is a 7" 1920x1200 IPS LCD touchscreen with a maximum screen luminance of 1300 nits and an active screen size of 95 x 142 mm / 3.72" x 5.95".

MENU Button and User Buttons

The MENU button (2) provides access to the camera menu, which is identical to that of the MVF-2. The four user buttons (3) can be assigned camera-specific functions as well as smallHD monitor functions.

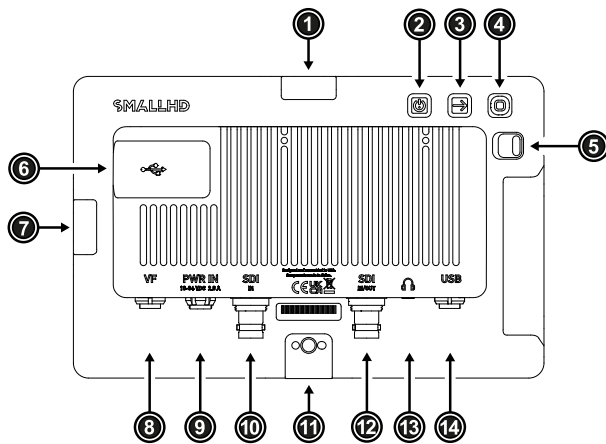

Rear

- 1 Mounting Point
- 2 POWER Button
- 3 BACK Button
- 4 Joystick
- 5 LOCK Slider
- 6 USB-C Slot
- 7 Mounting Point
- 8 VF Connector
- 9 PWR In Connector
- 10 SDI IN Connector
- 11 Mounting Points
- 12 SDI IN/OUT Connector
- 13 Headphones Connector
- 14 USB Connector

Mounting Points

The monitor has four ARRI Pin-Lock 1/4" mounting points (top (1), right (7), bottom & rear (11)), to attach the monitor to the camera or e.g. a rig.

POWER Button

The monitor can be switched on and off via the POWER button (2).

Joystick and BACK Button

The joystick (4) and the *BACK* button (3) are used for menu navigation and provide an alternative control option in environments where the touchscreen is difficult to use.

LOCK Slider

The *LOCK* Slider (5) locks all monitor controls including the touchscreen to prevent unintended triggering of functions.

USB-C Slot

The USB-C slot (6) accepts the same USB-C stick as the ALEXA 35, which can remain plugged in under a weatherproof cover during operation. Via the USB-C stick, firmware updates can be imported, and frame grabs, or 3D-LUTs stored.

VF Connector (CoaXPress)

The VF connector (8) is used to connect the CCM-1 to the camera. The interface transmits power, video and control data and supports cable lengths of up to 10 m (33 ft). If the CCM-1 is operated at a brightness of 100 nits, it can solely be powered via this interface. If higher brightness levels are required, the monitor must additionally be powered via the PWR In connector. The VF connector comes without a key, so the VF cables plug in regardless of their orientation.

PWR In Connector (3-pin Fischer)

The monitor can be supplied with additional power via the PWR In connector (9), which is required if the monitor is operated with a brightness above 100 nits, or when the monitor is used on third party cameras. The PWR In connector accepts input voltages from 10 – 34 V DC.

SDI IN (BNC)

When the MVF-2 and CCM-1 are used in parallel on an ALEXA Mini LF, or when the monitor is used with third party cameras, the CCM-1 receives the camera image via the SDI In connector (10). The SDI In connector accepts 1.5G and 3G SDI signals according to SMPTE ST 292-1:2012 and SMPTE ST 425-1:2014.

SDI IN/OUT (BNC)

As an input, the SDI IN/OUT connector (12) offers the same features as the SDI IN input, and both inputs can be used in parallel. As an output, it outputs the signal that is present at the SDI In connector.

Headphones Out

The headphone output (13) is a 3.5 mm jack that outputs all audio channels (same as the headphone output of the MVF-2).

USB Connector (5-pin LEMO)

When MVF-2 and CCM-1 are used in parallel on an ALEXA Mini LF, the CCM-1 can control the camera via the USB connector instead of the VF connector.

6 Power Supply

ADVICE

- ▶ Always keep the PWR connector accessible so that the cable can be unplugged quickly in case of emergency.
- ▶ Unplug the power cable by gripping the power plug, not the cable.
- ▶ Do not use power cables longer than 4m.
- ▶ Operate the system using only the type of power source indicated in the manual.
- ▶ Do not supply power outside the specified voltage range.

Power Inputs

The camera accepts input voltages from 20.5 to 33.6 V DC.

The BAT input is located on the rear interface (1) and is used to power the camera from 24 V onboard batteries using a battery adapter.

The LEMO 8-pin PWR input (3) allows to power the camera from block batteries or DC power supplies using cables KC50-S (K2.75007.0) or KC50-SP-S (K2.0001275).

Both inputs are equipped with an LED (2, 4) that indicates the status of the input.

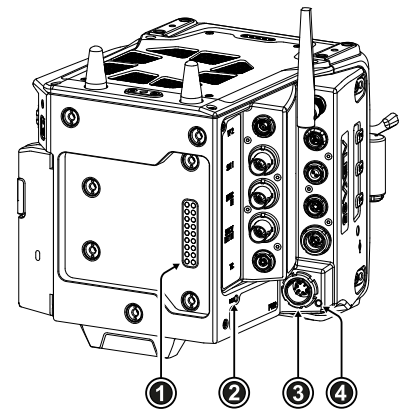

Switching On and Off

The *POWER* button (5) is located at the rear left of the camera. The *POWER* button's background light is illuminated when the supplied power is in the valid range. While the camera is booting up, the boot status LED (6) is flashing blue. As soon as the camera has finished the boot process, the boot status LED turns to solid blue.

- ▶ To switch on the camera, press the *POWER* button.
- ▶ To switch off the camera, press and hold the *POWER* button until the camera has switched off.

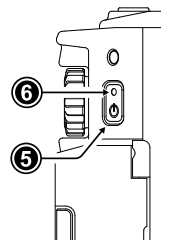

Status Information

The status of the power inputs is displayed on the HOME screen of the MVF-2 and the side display as well as in the Status Info.

BAT 100% 34% ↕ PWR 87% TEXT. K445 Default	When power is supplied through both the PWR and BAT input, a current symbol on the HOME screen indicates which input is being used. The preferred input to be used can be set in the camera menu.
---	---

The BAT entry can display two values when two B-mount batteries are used together (e.g. a hot swap unit and a main unit). The first value refers to the battery that sits directly on the battery adapter (usually the hot swap unit), the second value refers to the stacked battery. The camera will always draw power from the stacked battery first.

Additionally, the battery status can be read directly from the camera body via the two status LEDs (2, 4). The LEDs indicate which input is in use and whether sufficient power is available. A green LED indicates that the input is in use, a blue LED indicates that there is power at the input, but it is not in use. The power low warning is issued when the supply voltage is lower than 22.0 V.

Green: Active Input	Solid	Sufficient power
	Blinking	Warning, power low
Blue: Standby Input	Solid	Sufficient power
	Blinking	Warning, power low
White: Camera off	Solid	Sufficient Power
	Blinking	Warning, power low
Red	Blinking	Insufficient Power

Power Outputs

The main accessory outputs of the camera are the RS output and the 12 V output. In addition, appropriate accessories can be powered via the LBUS sockets, the ETH socket, the SERIAL socket or the AUDIO socket. The optional Power Distribution Module PDM-1 adds seven additional power outputs (4x 24 V, 2x 12 V, 1x 12 V Twist D-Tap) to the camera.

24 V Outputs	RS	(3.0 A max.)	12 V Outputs	12 V	(2.0 A max.)
	LBUS	(4.0 A max.)		AUDIO	(0.5 A max.)
	ETH	(0.5 A max.)		SERIAL	(200 mA max.)
	24 V (PDM-1)	(4.0 A max.)		D-Tap (PDM-1)	(2.0 A max.)

The total available power over all 24 V outputs is just below 100 W to be compliant with DIN EN 62368 PS2, with a max. current of 4.0 A.

The total available power over all 12 V outputs is 50 W, with a max. current of 2.0 A.

Power Consumption

The ALEXA 35 draws between 85 W and 135 W while recording, depending on the set recording resolution and sensor frame rate (with MVF-2 connected, but no further accessories attached).

The camera will switch off at 19.5V supply level.

Input Priority

In case both power inputs are used, the camera supports to set which input is to be used preferentially.

- ▶ Select *MENU > System > Power > Priority* to set the power input priority.

Following options are available:

Power In (PWR)	Always use the PWR input when power is available on BAT and PWR.
Onboard Battery (BAT)	Always use the BAT input when power is available on BAT and PWR.
Highest Voltage	Use the input supplying the higher voltage.

Power Warning

For each power input, a threshold can be set at which a battery warning is triggered. When the threshold is reached, the battery values on the HOME screen as well as in the Status Info blink orange.

- ▶ Select *MENU > System > Power > Power In (PWR) Warning (%)* to set the warning threshold (%) for the PWR input.
- ▶ Select *MENU > System > Power > Power In (PWR) Warning (V)* to set the warning threshold (Volts) for the PWR input.
- ▶ Select *MENU > System > Power > Onboard Battery (BAT) Warning (%)* to set the warning threshold (%) for the BAT input.

- ▶ Select *MENU > System > Power > Onboard Battery (BAT) Warning (V)* to set the warning threshold (Volts) for the BAT input.

Info: When using two B-Mount batteries simultaneously, the BAT warning will not be issued until both batteries have reached the warning threshold.

BAT Unit Preference

The status of the power inputs can be displayed either in Volt or as a percentage of total battery capacity.

- ▶ Select *MENU > System > Power > BAT Unit Preference* to set the preferred unit between **Volt** and **Percent**.

Info: Percentage can only be displayed if supported by the power source.

PWR/BAT LEDs

In case the status display via the two power LEDs is not needed, both LEDs can be switched off.

- ▶ Select *MENU > System > Power > Enable PWR/BAT LEDs* to activate / deactivate PWR/BAT LEDs.

BAT Auto Boot Up

When the camera was switched off due to a power cut, it automatically boots up as soon as power is present again. This behavior is optional for the BAT input, e.g. to avoid power cycling with flat batteries.

- ▶ Select *MENU > System > Power > BAT Auto Boot Up* to enable / disable automatic boot up for the BAT input.

7 Menu Operation

The camera settings are divided into 11 submenus:

- Recording
- Media
- Monitoring
- Image
- System
- Setup
- User Buttons
- Metadata
- Lens & ECS
- Info
- Alerts

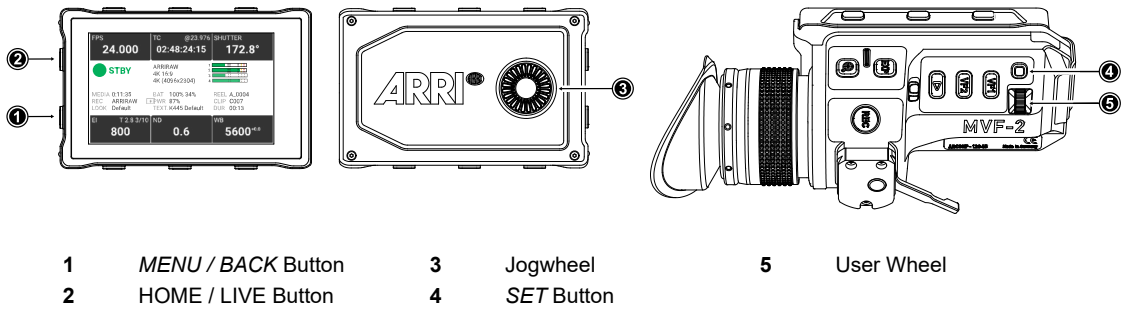

- ▶ While the HOME screen is displayed, press the HOME / LIVE button (2) or swipe to the right to display the live view.
- ▶ While the HOME screen is displayed, press the MENU / BACK button (1) or swipe to the left to access the camera menu.

Rotate the jogwheel (3) or the user wheel (5) to scroll up or down to select the desired menu entry: Entries with a “>” at the end navigate to a sub menu. To navigate to a sub menu press the jogwheel center or the SET button (4). To return to a higher menu level press the MENU / BACK button.

Entries with a value allow for direct editing. To edit a value press the jogwheel center or SET button, then rotate the jogwheel or user wheel to select the desired value. Press the jogwheel center or SET button to confirm the change or press CANCEL to discard.

Entries with a check box allow for direct activation/deactivation. Press the jogwheel center or SET button to activate/deactivate the setting.

To leave the menu press the HOME / LIVE button (2) or swipe to the right.

The jogwheel and the user wheel + SET button provide identical functionality. For the remainder of this manual, whenever the term jogwheel is used, it refers to the jogwheel and the user wheel. Whenever “press the jogwheel” is used, it refers to the jogwheel center and the SET button.

7.1 HOME Screen

The HOME screen shows the most important camera settings and gives quick access to changing them through the screen buttons.

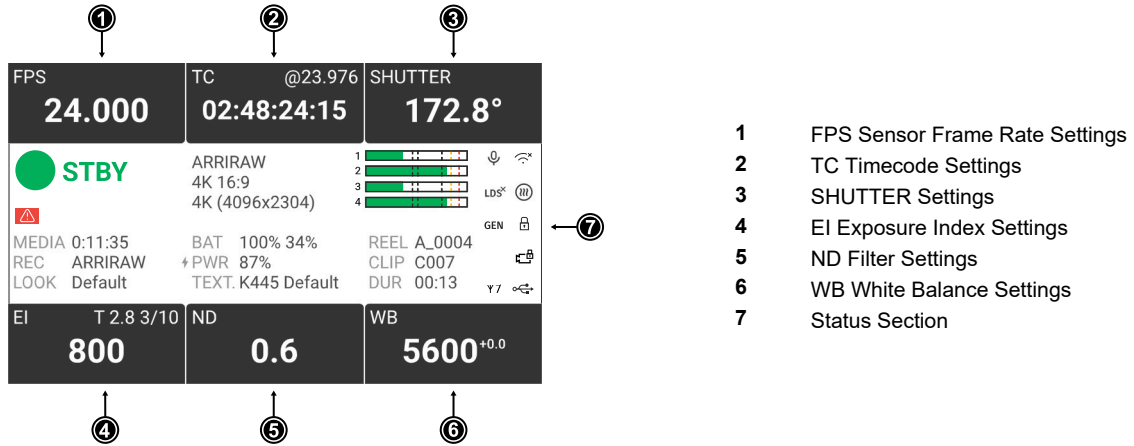

FPS (Sensor Frame Rate)

The FPS label shows the current sensor frame rate in frames per second. Press the FPS screen button to adjust the sensor frame rate. The FPS label turns orange if the sensor frame rate does not match the project frame rate.

TC (Timecode)

The TC label shows the current timecode value and project rate. Press the TC screen button to access the timecode settings. The TC label turns orange if a timecode misconfiguration exists. Press the TC screen button for more information.

SHUTTER

The SHUTTER label shows the current shutter angle or exposure time. Press the screen button to set the shutter of the sensor. The shutter unit can be set to display either shutter angle (5.0° to 356.0°) or exposure time (1 second to 1/8000 seconds). The maximum shutter angle is limited by the resulting exposure time (1 second max.). Shutter angle and sensor frame rate determine exposure time of the sensor in seconds by the following equation: exposure time = shutter angle / (360 x FPS).

EI (Exposure Index)

Shows the current exposure index. Press the screen button to adjust the exposure index in a range from 160 to 6400 ASA without Enhanced Sensitivity Mode or 2560 to 6400 ASA with Enhanced Sensitivity Mode.

ND Filter

The ND label shows the current ND filter value of the built in FSND (Full Spectrum Neutral Density) filter stage. Press the screen button to change the ND filter.

WB (White Balance)

The WB label shows the current white balance and tint. Press the screen button to set the white balance. This is the color temperature of the light source that the camera is currently adjusted for. In addition to the red/blue correction of the white balance, the camera can also compensate for a green/magenta tint. This value, called CC (color compensation), is shown as an exponent of the WB value. Positive values are marked with a "+" and negative values with a "-".

White balance can be adjusted from 2000 to 11000 Kelvin (here: 5600) in steps of 10 K for red/blue correction. Color compensation for green/magenta tints can be adjusted in a range from -16.0 to +16.0. Positive or negative CC color compensation values then appear as an exponent of the WB value (here: +0.0).

Status Section

The status section on the home screen shows key data about recording, power supply, remaining media capacity and more:



Camera Status

- STBY Standby - ready for recording.
- PREREC Prerecording.
- REC Recording.
- PLAY Camera is in playback mode.
- ERASE Medium erase in progress. Active erasing disables recording.
- None Idle, recording not possible (e.g. no media inserted, media is full).
- ERROR System error occurred. See *MENU > Alerts* for details.

ARRIRAW
4K 16:9
4K (4096x2304)

Codec, Sensor Mode & Recording Resolution

Currently set codec, sensor mode and recording resolution.



Audio Meters

The audio meters are only displayed when audio recording is enabled. When audio recording is disabled, a crossed out speaker icon is displayed. Black markers are shown at signal levels -20, -18, -9 dBFS. The yellow marker at -5 dBFS and the red marker at -2 dBFS indicate a signal close to clipping.

REEL A_0004
CLIP C007
DUR 00:13

Clip Information

Displays the current reel name, the current clip number and the duration of the current clip (while recording) or of the last recorded clip (during standby).

BAT 100% 34%
PWR 87%
TEXT. K445 Default

Battery Status and Texture

Displays the status of the power inputs and the active texture.

MEDIA 0:11:35
REC ARRIRAW
LOOK Default

Media Capacity & Recording and Look Settings

Displays the remaining capacity of the recording medium, the active recording processing (ARRIRAW or LogC4) and the active look file.

Status Icons:



The microphone icon indicates that the internal microphones are active.



Internal microphones are muted.



WiFi is active and in client mode. The camera is connected to a network.



WiFi is active and in client mode. The camera is not connected to a network.



WiFi is active and in host mode.



The ARRI ECS White Radio is active and uses the displayed channel number.



Touch Lock Icon. The touchscreen functionality of the MVF-2 flip-out monitor is disabled.



MVF-2 Lock Icon. MVF-2 buttons and touchscreen are locked.



Camera Lock Icon. Camera buttons are locked.







The Frame Grab icon indicates active frame grabbing. The icon turns orange if frame grabbing failed (e.g. no USB medium is inserted).



The Genlock icon indicates that the camera is synchronized to a Genlock or timecode signal. The icon turns orange when the source signal is missing or is not usable.



The MVF-2 eyepiece heater is on. The icon turns gray when the heater is not heating (eyepiece temperature is > 15 °C (59 ° F)).

- CAL** The CAL icon indicates that a lens motor calibration is required. The icon turns black when calibration is in progress and expires when calibration has finished.
- LDS^x** Indicates that the LDS interface is disabled.
-  The USB icon indicates a connected USB medium. The icon turns gray when the medium is read only, and orange if the medium is not usable.
-  The fan icon indicates that the camera needs to increase the fan speed above 20 dB noise emission level. The icon turns orange when the fan speed exceeds 20 dB.
-  The temperature icon indicates that the camera temperature is increased. The icon turns red when the camera temperature is out of range.
-  Indicates an active alert state. See *MENU > Alerts* for detailed information.

7.2 Working with Settings/Lists and Importing Files

For certain settings, the camera menu operates with preset lists that come with a default content and that can be adjusted to the user's preference. You can add values to and delete values from these lists, so that only project relevant values are displayed. Value based lists contain entries that can be edited directly in the camera (e.g. Shutter and White Balance presets) while file based lists contain files that are installed on the camera or were imported from the USB medium (e.g. Looks and Frame Lines).

Settings with value based lists:

- HOME > FPS
- HOME > SHUTTER
- HOME > WB

Settings with file based lists:

- MENU > Image > Look > Look
- MENU > Monitoring > Frame Lines > Frame Line
- MENU > Setups > User Setups Installed
- MENU > Lens & ECS > Lens Data > Lens Tables Installed

Adding Entries to Value based Lists

The camera offers two input methods for adding entries to a list or changing settings. The numeric keypad is for entering a value directly, while the slider is for fine-tuning a value (e.g. for fine-tuning the shutter when filming monitors). This setting screen is used not only when values are to be added to a list, but also for most of the menu settings.

- ▶ Select e.g. HOME > FPS > ADD.

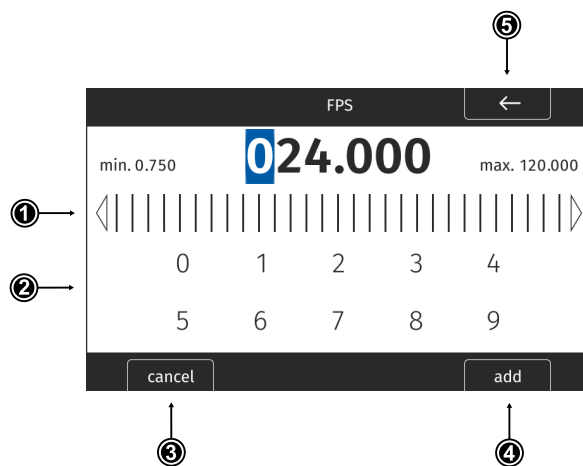

Operation via Jogwheel

- ▶ Rotate the jogwheel to change the value of the first digit. Then press the jogwheel to move to the next digit and adjust. The blue cursor indicates the selected digit.
- ▶ Press the *BACK* button (5) to reselect the previous digit.
- ▶ Press the *ADD* button (4) to add the new value to the list, or the *CANCEL* button (3) to discard and exit.

Operation via Touchscreen

- ▶ Use the touch slider (1) to change the value of the first digit. Then press on the slider or the value to move to the next digit and adjust. The blue cursor indicates the selected digit.
- or
- Use the numeric keypad to enter a value directly.
- ▶ Press the *BACK* label (5) to reselect the previous digit.
- ▶ Press the *ADD* label (4) to add the new value to the list, or the *CANCEL* button (3) to discard and exit.

Importing Files

For looks, frame lines, user setups and lens tables the camera offers the option to import files from the USB medium as well as from a factory default presets. To import files from a USB medium into the camera, the USB medium needs to be prepared with a certain folder structure, see chapter "[User Storage](#)", page 29 for more information. The maximum file name length allowed is 64 characters including the file extension. Files with a name exceeding 64 characters cannot be displayed in camera lists. Special characters <, >, :, ;, ", /, \, | and * in file names are displayed and replaced with a "?" in the camera menu.

- ▶ Select e.g. *MENU > Monitoring > Frame Lines > Frame Line > ADD*.

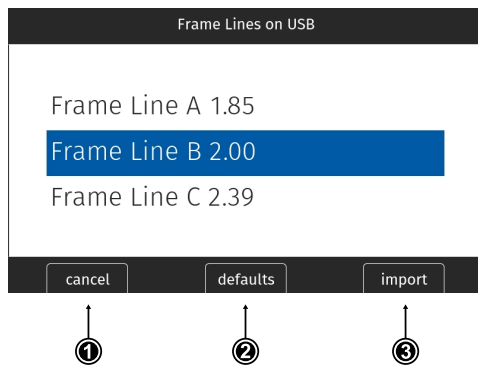

- ▶ Select a frame line file to import from the *USB* list or select *DEFAULTS* (2) to select a frame line file from the factory defaults list.
- ▶ Press the *IMPORT* button (3) or the jog-wheel to add the selected frame line to the frame lines list, or the *CANCEL* button (1) to exit.

Deleting List Entries

- ▶ Select e.g. *HOME > FPS*.
- ▶ Scroll to the entry to be deleted.
- ▶ Press the *DELETE* button.
The selected entry is marked for delete.
- ▶ Press the *DELETE* button again to delete the selected entry or rotate the jogwheel to cancel.

Maximum Entries per List

All lists have a maximum number of entries they can hold. Whenever a list is full, the *ADD* button is grayed out and a message is shown. You need to delete entries from the list first in order to add new ones. The following table lists the maximum number of entries for each type of list:

List	FPS, Shutter	User Setups	White Balance	Looks, Textures	LDA	Frame Lines
Max. Entries	16	20	32	50	200	256

7.3 On-screen Keyboard

When working with textual parameters on the camera, an on-screen keyboard serves to enter text. You need to use the keyboard, for example, to enter the name when saving a user setup.

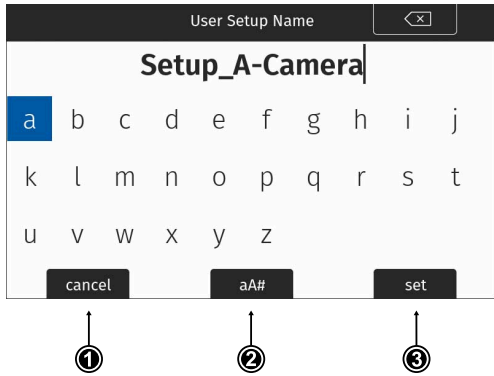

- ▶ Use the jogwheel to select and enter characters.
- ▶ The *CLEAR* button (4) deletes the digit to the left of the cursor. Press and hold the button to clear the entire value.
- ▶ The *aA#* button (2) toggles between lower case, upper case and numeric text entry.
- ▶ Press the *SET* button (3) to save the file, or the *CANCEL* button (1) to exit.

7.4 Side Display

The side display of the camera provides access to the main parameters. This can be useful for applications where it is not necessary or possible to connect an MVF-2. The display is divided into four pages, which can be switched between via the navigation bar at the top of the screen:

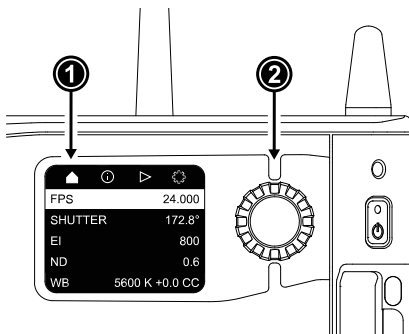

- ⏠ The *Home Page* (1) offers to adjust the main parameters Sensor FPS, Shutter, Exposure Index, ND Filter and White Balance.
- ⓘ The *Info Page* provides an overview about other important parameters such as the remaining time of the recording medium or the set Look and Texture.
- ▶ The *Playback Page* offers a simple in-camera playback control.
- ⚙ The *Settings Page* offers to adjust settings for the side display and camera body and to erase the recording medium.

Menu Operation

- ▶ Rotate the side display jogwheel (2) to select between pages.
- ▶ Press the jogwheel to access a page.
- ▶ Rotate the jogwheel to scroll up or down within the page.
- ▶ To edit a setting (*Home Page* and *Settings Page*), press the jogwheel, then rotate to select the desired value. Press to confirm the change.
- ▶ To leave a page, scroll up into the navigation bar and press the jogwheel.

For playback control via the side display, please see "[Playback](#)", Page 68.

Display Mode

- ▶ Select *SETTINGS > Display Mode*.
Following options are available:

- On** The side display is always switched on.
- Off** The side display is switched off. Press and hold the jogwheel for 2 seconds to switch it back on.
Alternatively, the side display can be switched off by pressing and holding the jogwheel for 2 seconds.
- Sleep** The side display switches to sleep after 20 seconds of non-use. Reactivate by using the jogwheel.
- ND** The side display switches to sleep after 20 seconds of non-use and displays the current ND Filter value.
Reactivate by using the jogwheel.

7.5 User Storage

The camera saves data such as user setups and frame grabs to a USB-C memory stick. Look files, frame lines and software updates can be loaded into the camera from the memory stick.

The USB-C slot (1) is located behind the media door, above the recording media slot. Slide down the media door release (2) to open the media door.

The camera supports exFAT formatted memory sticks using one partition within a Master Boot Record (MBR) partition table and a maximum capacity of 256 GB. A special folder structure is used in order to work with the camera.

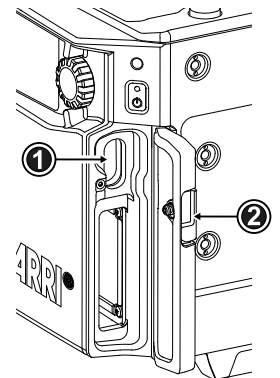

Prepare Folder Structure

The camera can only load files from a correctly prepared USB medium with the required folder structure. Preparing the folder structure on the USB medium within the camera will not alter existing folders and files on the USB medium.

- ▶ Open the media door and insert the USB medium.
- ▶ Select *MENU > Media > Prepare USB Medium* to create the ALEXA 35 folder structure on the USB medium:

ARRI/ALEXA35/	FRAMELINES	For frame line imports to camera
	GRABS	For stored frame grabs
	LDA	For lens table import/export
	LICENSES	For license file installation
	LOG	For exported camera logfiles
	LOOKFILES	For look file import/export
	SETUPS	For import/export of user setups
	SUP	For software update installation
	SENSOR	For import/export of User Pixel Mask files
	TEXTURES	For Texture import
ARRI/ECS		For LBUS device update installation



The USB icon on the HOME screen and in the Status Info indicates a connected medium. A gray icon indicates that the medium is read only. An orange icon is displayed if the medium is not supported.

USB Info

- ▶ Select *MENU > Info > USB Info* for additional information on the USB medium.

7.6 Info Screens

The INFO screens provide detailed information about the current state of the camera system.

- ▶ Select *MENU > Info*.

The *Info* sub menu contains the following lists:

Version Info

<i>Software</i>	The camera software version.
<i>Revision</i>	Revision of camera software version.
<i>FPGA</i>	Firmware version of active FPGA.
<i>MVF-2 Software</i>	Software version of MVF-2.
<i>Lens Mount Software</i>	Software version of lens mount.

System Info

<i>Time + Date</i>	Current system time and date of the camera.
<i>Camera Serial No.</i>	Serial number of camera.
<i>Operating Hours</i>	Total operational time of the camera in hours:minutes.
<i>Sensor Temperature</i>	Current temperature of image sensor.
<i>Sensor Temp. State</i>	Rates the sensor temperature according to OK, warning, or error.
<i>Camera Temp. State</i>	Rates the camera temperature according to OK, warning, or error.

False Color Info

The False Color Info displays a reference chart explaining the color coding used for the False Color exposure tool.

PWR/BAT LED Info

The PWR/BAT LED Info displays a reference chart explaining the LED states of the PWR and the BAT LEDs.

Media Info

<i>Status</i>	Status of the recording medium.
<i>Model</i>	Name/model of the recording medium.
<i>SN#</i>	Serial number of the recording medium.
<i>FW Version</i>	Firmware version of the recording medium.
<i>Size</i>	Total storage size of the recording medium.
<i>Clip Count</i>	Number of clips on the recording medium.

USB Info

<i>Status</i>	Status of USB medium.
<i>Storage Free/Total</i>	Free and total available storage on USB medium in megabyte.
<i>Frame Line Files</i>	Number of frame line files on USB medium.
<i>License Files</i>	Number of license files on USB medium.
<i>Look Files</i>	Number of look files on USB medium.
<i>Setup Files</i>	Number of user setup files on USB medium.
<i>SUP Files</i>	Number of SUP (Software Update Package) files on USB medium.
<i>LDA Files</i>	Number of LDA (Lens Data Archive) files on USB medium.
<i>Texture</i>	Number of Texture files on USB medium.

Info: The number entries consist of two numbers, the number of files on the USB medium and the number of files recognizable by the camera.

Network Info

<i>WiFi Network</i>	Name of connected network (client mode).
<i>WiFi IP</i>	IP address of the camera via WiFi.
<i>LAN IP</i>	IP address of the camera via Ethernet.
<i>Web Remote</i>	URL address of camera remote control website.
Streaming Addressing	Type of addressing used for metadata streaming (Unicast / Multicast).
Streaming Address	IP address of the metadata streaming receiving device.
Streaming Port	Metadata streaming port.

Lens Info

<i>Lens Type</i>	Type of lens (LDS, Cooke, ENG, EF).
<i>Model</i>	Lens model name according to manufacturer.
<i>Serial No.</i>	Serial number of lens.
<i>Extender</i>	Name of extender (if used).
<i>Focal Length</i>	Focal length of lens in mm.
<i>Focus</i>	Current focus distance of lens.
<i>Iris</i>	Current iris value of lens.

User Button Info

The user button info screen lists the functions assigned to the user buttons of the camera body and the MVF-2.

Export HW Info File

HW (HardWare) Info files are required to generate licenses in the ARRI License Shop or may be requested by camera service to get detailed information on the camera's hardware and components revisions.

The HW Info file will be exported to the USB medium in the ARRI/ALEXA35/LICENSES folder.

Export Logfiles

Logfiles help ARRI camera service to analyze potential problems. In normal circumstances, logfile export is not required.

Export Logfiles combines the camera logfiles, HW Info file, current user setup and other diagnostic files into a .zip archive and stores the archive in the ARRI/ALEXA35/LOG folder on the USB medium. Privacy sensitive information such as WiFi password and look files are not exported.

8 Status Information and Overlays

The camera displays camera status information on the EVF and the SDI outputs. At the top and bottom of the screen, the camera displays status information in text form. The top status bar displays the current settings of sensor FPS, shutter angle, exposure index, ND filter, and white balance. The bottom status bar displays information about the battery level, reel and clip, camera status, remaining recording time, and timecode. On the left and right side of the screen, icons provide information about the current status of the camera. Furthermore, additional overlays such as lens data and an electronic horizon can be displayed.

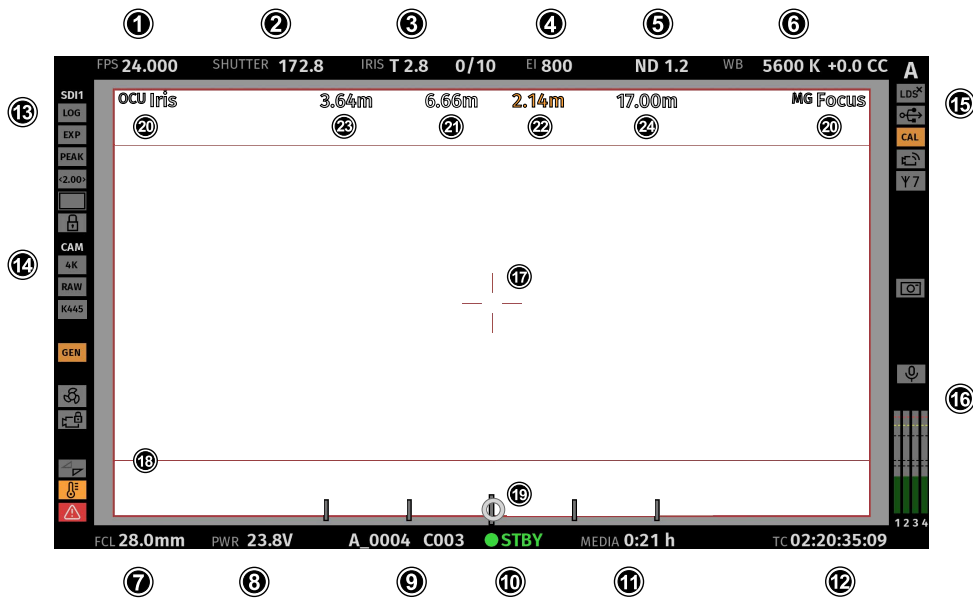

Status Info Top

- 1 Display of the set sensor frame rate. The FPS label turns orange if the sensor frame rate does not match the project rate.
- 2 Display of the set shutter (shutter angle or exposure time).
- 3 Display of the lens iris, including fractions of a stop (if lens data is available).
When using a lens extender, the iris value is displayed in brackets (recalculated value).
- 4 Display of the set exposure index.
- 5 Display of the set ND filter. The value is blinking while the filter changes.
- 6 Display of the set white balance.

Status Info Bottom

- 7 Display of the focal length of the lens (if lens data is available).
When using a lens extender, the focal length value is displayed in brackets (recalculated value).
- 8 Displays the active power source (onboard battery (BAT) or power in (PWR)) and its supply level. If the level reaches the configured warning threshold, the value starts flashing orange.
- 9 Display of the current reel and clip number.





- 10 Display of the camera status:

STBY	Standby - ready for recording.
PREREC	Prerecording.
REC	Recording.
PLAY	Camera is in playback mode.
ERASE	Medium erase in progress. Active erasing disables recording.
None	Idle, recording not possible (e.g. no media inserted, media is full).
ERROR	System error occurred. See <i>MENU > Alerts</i> for details.









- 11 Display of the remaining capacity of the recording media at current sensor frame rate and codec, in real time. When media capacity is less than two minutes, capacity values starts flashing orange.
- 12 Display of the current timecode. The TC label turns orange if the sensor frame rate does not match the project rate.

Status Info Left







13 EVF / SDI 1 / SDI 2 Status

-  Output processing icons. Shows the current processing for the respective output (LogC4, Look or Wireless Video Optimized for LogC4).
-  Exposure tool icon. Indicates that False Color is active on the respective output.
-  Peaking Icon. Indicates that Peaking is active on the respective output.
-  Anamorphic Desqueeze icon. Indicates that Anamorphic Desqueeze is active and which lens squeeze factor is applied.
-  Magnification icons. Indicate that the output shows less image content than actually recorded.

14 Camera Status

-  Shows the current Recording Resolution (4.6K, 4K, UHD, 3.3K, 3K, 2K, HD) .
-  Shows the current recording processing (RAW for ARRIRAW, or LOG (LogC4) for Apple ProRes).
-  Shows the currently set Texture.
-  Genlock icon. Indicates that the camera is synchronized to a Genlock or timecode signal. The icon turns orange when the sync signal is missing or is not usable.
-  The fan icon indicates that the camera needs to increase the fan speed above 20 dB. The icon turns orange when the fan speed exceeds 20 dB.
-  Camera lock Icon. Indicates that the camera body controls are locked.
-  Mirror image icons. Indicate that mirroring is applied to the image.
-  Temperature warning icon. Indicates that the camera temperature is increased.
-  Alert Icon. Indicates an active alert state. Alerts require the user's immediate attention and persist until resolved. See MENU > Alerts for further information.

Status Info Right

- 15  Indicates that the lens mount data interface has been disabled manually (e.g when custom lens tables are used).
-  USB icon. Indicates connected USB medium.
-  Calibration icon. Indicates that lens motor calibration is required. The icon turns gray when calibration is in progress and expires when calibration has finished.
-  WiFi Icon. Indicates that WiFi is active (host mode, client mode.) The client mode icon turns orange if the camera is not connected to a network.
-  White Radio icon. Indicates that White Radio is active and displays the set channel number.
-  Frame Grab icon. Indicates frame grabbing. The icon turns orange if frame grabbing failed (e.g. no USB medium is inserted).

16 Audio Section



Internal microphone icons. Indicate that internal microphones are active/muted.

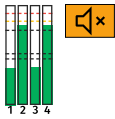

Audio meters. Indicate audio recording. Displays the current level of the audio channels. If audio recording is not possible (e.g. sensor fps != project frame rate), an orange speaker icon is displayed instead of the meters. Black markers at signal levels -20, -18, -9 dBFS for reference test tone. Yellow marker at -5 dBFS and red marker at -2 dBFS indicate a signal close to clipping. A red frame around the meter indicates a clipping at the A/D stage.

Overlays

- 17 Center marker, marks the center of the image to help in framing.
- 18 Frame line (here: ARRI 1:2.39)
- 19 Electronic Horizon overlay. Can be set to display numeric roll and tilt values.
- 20 The Master Grips / OCU-1 Control overlay indicates which axis is controlled by connected Master Grips and OCU-1. The overlay lights up white when there is control over the axis and gray when there is no control (e.g. no motor connected). The overlay flashes orange briefly when control of the axis is lost (e.g. through override from a hand unit).
- 21 The focus distance overlay displays the current focus distance (if lens data is available).
- 22 Distance measure overlay, displays readings from distance measurement devices connected to the SERIAL connector.
- 23 DoF overlay displaying the calculated depth of field near focus distance (if lens data is available).
- 24 DoF overlay displaying the calculated depth of field far focus distance (if lens data is available).

Application of Status Info on Monitoring Outputs

- ▶ Select *MENU > Monitoring > VF > EVF Overlays > Status Info* to configure application of status information for the EVF.
- ▶ Select *MENU > Monitoring > SDI > SDI 1 Processing > Overlays > Status Info* to configure application of status information for the SDI 1 output.
- ▶ Select *MENU > Monitoring > SDI > SDI 2 Processing > Overlays > Status Info* to configure application of status information for the SDI 2 output.

Following options are available:

- Off** Status information is not displayed.
- Overlay** Status information is displayed and overlaid on the captured image.
- Safe** Status information is displayed around the captured image.



User Buttons *VF Status Info*, *SDI 1 Status Info* and *SDI 2 Status Info* support to quickly set the Status Info on the respective output.

Configuration of Status Info Components

- ▶ Select *MENU > Monitoring > VF > EVF Overlays > Status Components* to configure the status components for the EVF.
- ▶ Select *MENU > Monitoring > SDI > SDI 1 Processing > Overlays > Status Components* to configure the status components for the SDI 1 output.
- ▶ Select *MENU > Monitoring > SDI > SDI 2 Processing > Overlays > Status Components* to configure the status components for the SDI 2 output.

Following options are available:

- Camera Index Letter** Displays the Camera Index Letter in the top right corner of the image (SDI only). Helps to identify camera image output when shooting with multiple cameras.

Electronic Horizon	Displays a horizon overlay (19) representing the roll and tilt of the camera measured by the camera's position sensor. This sensor can be " reset " if it appears to have an offset.
Show Numeric Values	Sub-option of Electronic Horizon. Shows the tilt and roll of the camera in degrees as measured by the camera's position sensor.
Lens Data	Enables/disables iris (3) and focal length (7) overlays.
Lens Focus Distance	Enables/disables focus distance overlay (21).
Depth of Field	Enables/disables the depth of field overlays (23, 24).
Distance Measure	Enables/disables status overlay of distance readings from a distance measure connected to the SERIAL connector (22).
Master Grips / OCU-1 Control	Enables/disables status overlay of Master Grips / OCU-1 axis control (20).
Info Left	Enables/disables the left section of the status info.
Info Right	Enables/disables the right section of the status info.
Info Top	Enables/disables the top section of the status info.
Info Bottom	Enables/disables the bottom section of the status info.
Audio	Enables/disables display of the audio levels (16).
Timecode	Enables/disables display of the timecode (12).

Overlay Brightness

The camera allows adjusting the brightness of the status overlays.

- ▶ Select *MENU > Monitoring > VF > EVF Overlays > Overlay Brightness* to adjust the overlay brightness for the EVF.
- ▶ Select *MENU > Monitoring > SDI > SDI 1 Processing > Overlays > Overlay Brightness* to adjust the overlay brightness for the SDI 1 output.
- ▶ Select *MENU > Monitoring > SDI > SDI 2 Processing > Overlays > Overlay Brightness* to adjust the overlay brightness for the SDI 2 output.
- ▶ Set the overlay brightness in a range from **1** (the lowest brightness) to **4** (the highest brightness).

Flip-out Monitor Status Bar

The flip-out monitor of the MVF-2 shows a slightly different status information than the EVF and the SDI outputs. When set to display the camera live image, a status bar is displayed below the image. The flip-out monitor status bar is separated into five pages:

Lens Data Recording Main Parameters Audio and Timecode Status Icons

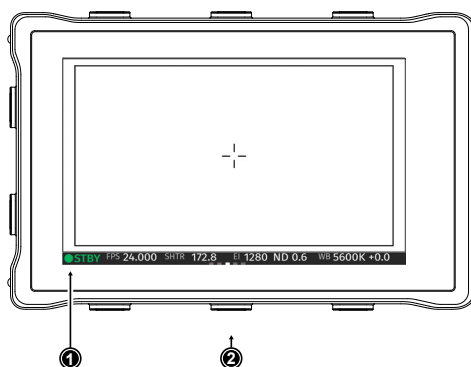

- ▶ Use the left and right lower screen buttons to change the status bar (1) content. The center lower screen button (2) returns to display the main parameters.

9 Main Parameters

9.1 Project Settings

The project settings menu contains settings that should be configured at the beginning of each project and can be found at *MENU > Recording > Project Settings*.

Project Rate

The project rate determines how many frames the timecode counts per second, and also determines the frame rate at which clips are played back.

Changing the project frame rate will automatically change the sensor frame rate and the SDI frame rates to the same frame rate. It is still possible to have different frame rates for these settings by changing the sensor frame rate or the SDI frame rates individually.

- ▶ Select *MENU > Recording > Project Settings > Project Rate*.

The following project rates are available:

Project Rate	Scan Format	Sensor Real-time Recording
23.976p	Progressive	23.976 fps
24p	Progressive	24 fps
25p	Progressive	25 fps
29.97p	Progressive	29.97 fps
30p	Progressive	30 fps
48p	Progressive	48 fps
50p	Progressive	50 fps
59.94p	Progressive	59.94 fps
60p	Progressive	60 fps

Next Reel Count

The next reel count sets the reel number assigned to the next new recording medium. The camera will automatically increment the reel number each time a new recording medium is inserted, erased and recorded on. If a previously used media is reloaded in the camera (comparable to a short end of a film roll), it will keep its reel number and the camera will increment the reel count. If the media is loaded in another camera, it keeps its name, but a new folder with the according camera ID and reel number is created in the root folder of the media. It is possible, but usually not necessary, to manually change the next reel number.

- ▶ Select *MENU > Recording > Project Settings > Next Reel Count*.
- ▶ Set the desired next reel count between 0001 and 9999.

Camera Index

Each camera can be assigned a unique two character camera index so that you can identify the individual camera unit (A, B, C etc.) in clip and reel names. For additional information please see ["Clip Naming Scheme", page 63](#).

- ▶ Select *MENU > Recording > Project Settings > Camera Index* to set the camera index.

Camera Index Color

Set the color of the camera index letter displayed in the Status Info of the SDI outputs (e.g. to match it to the color coding of your cameras).

- ▶ Select *MENU > Monitoring > SDI > SDI 1 Processing > Overlays > Status Components > Camera Index Letter* to display the camera index letter in the SDI 1 Status Info.
- ▶ Select *MENU > Monitoring > SDI > SDI 2 Processing > Overlays > Status Components > Camera Index Letter* to display the camera index letter in the SDI 2 Status Info.
- ▶ Select *MENU > Recording > Project Settings > Camera Index Color* and set the camera index color

Lens Squeeze Factor

The lens squeeze factor determines the factor that is used for anamorphic desqueeze on the monitoring outputs when using anamorphic lenses. This value is also written into the metadata of the clip and allows video players and editing software to automatically desqueeze clips that have been shot with anamorphic lenses. Frame lines will automatically scale to the selected lens squeeze factor.

- ▶ Select *MENU > Recording > Project Settings > Lens Squeeze Factor* and select the lens squeeze factor.

Following options are available:

1.00 1.25 1.30 1.33 1.50 1.65 1.80 1.85 2.00



The set lens squeeze factor is indicated through the desqueeze icon displayed in the Status Info (here: 2.00).

Info: The availability of the lens squeeze factors depends on the selected sensor mode.

9.2 Sensor Frame Rate

The sensor frame rate determines the amount of frames generated by the sensor in one second. For sync sound recording, the sensor frame rate matches the project speed. If you record a clip at a higher sensor frame rate than the project rate, a slow motion effect occurs during playback. Recording at a lower sensor frame rate results in a time lapse effect. The maximum possible sensor frame rate is dependent on the set Sensor Mode, Codec and used Compact Drive model (1 TB, 2 TB).

- ▶ Select *HOME > FPS* to set the sensor frame rate.
- ▶ Select a preset from the list or [add](#) a custom frame rate.



User Buttons *FPS Increase / Decrease* support to quickly change between FPS presets.

User Button *FPS Preset* supports to switch to a defined frame rate.

9.3 Shutter

The electronic shutter of the camera can be adjusted from 5° - 356° shutter angle or 1 to 1/8000 seconds (depending on the set frame rate). The preferred shutter unit can be set by the user.

- ▶ Select *MENU > System > Shutter Unit*.

Following options are available:

Shutter Angle

Converts exposure time into the angle of a virtual rotating mirror shutter as in film cameras. A fixed angle creates varying exposure times with varying frame rates.

Exposure Time

Shows the effective sensor exposure time. With varying frame rates, it remains identical.

Info: Maximum exposure time with a given frame rate is $1/\text{fps}$, with a limit of 1/1 seconds. When the selected exposure time is no longer possible because you changed the frame rate, the camera uses the longest exposure time possible. For example, if you configured 1/25 s at 25 fps and you change the sensor fps to 50, the camera will use 1/50 s.

- ▶ Select *HOME* > *SHUTTER* to adjust the shutter.
- ▶ Select a preset from the list or [add](#) a custom shutter value to the list.



User Buttons *Shutter Increase / Decrease* support to quickly change between shutter presets.

Info: The camera sensor is optimized for exposure times shorter than 1/24 s and image artifacts like individual overexposed pixels may appear when using longer exposure times.

9.4 Exposure Index

The exposure index selects which sensor signal becomes mid gray in the LogC4 image and consequently in the monitor image. Mid gray is encoded as 28% in the LogC4 signal. When the output is set to Rec. 709 and no look file is loaded that modifies the signal, mid gray becomes 40% in the video signal.

The LogC4 signal is exposure normalized. That means, when one closes (opens) the aperture and increases (decreases) the exposure index by an equivalent amount, mid gray stays at the same value.

Neither varying the exposure nor the exposure index changes the dynamic range of the sensor. By exposing the sensor differently, the distribution of the tonal range below and above mid gray changes. This is shown in the figure below.

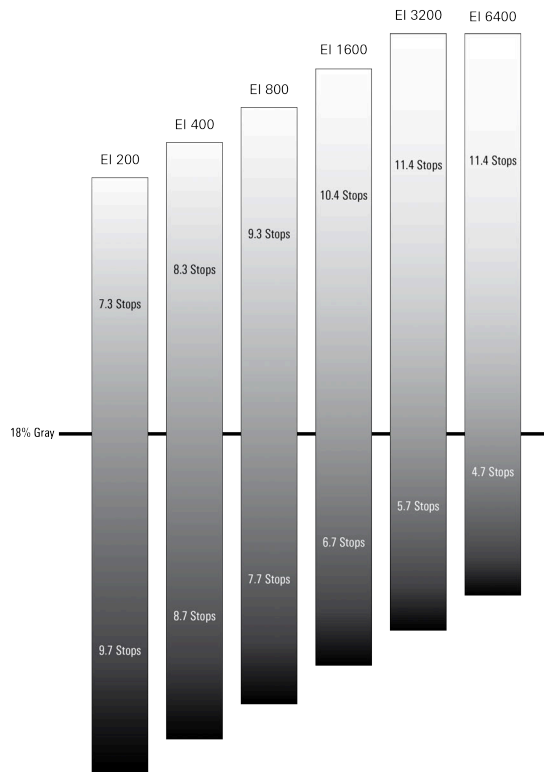

The LogC4 encoding maintains a fixed relation between signal values and the relative exposure stops in the scene. For example, a signal value of 10% represents an exposure of 1.5 stops below mid gray (which is at a signal level of 28%). A signal value of 40% represents 2 stops above mid gray. These relations stay constant regardless of the exposure index. Because the number of stops above mid gray that can be captured increases with decreasing exposure, the maximum of the LogC4 function will change with exposure index.

Enhanced Sensitivity

In addition to the regular exposure index from EI 160 to EI 6400, it is possible to choose EI 2560 to EI 6400 with Enhanced Sensitivity (ES) turned on. Enhanced Sensitivity is an in-camera noise reduction that provides cleaner images in low light. ES is an in-camera process, which means it is baked into ARRIRAW and ProRes files. There also are some frame rate and shutter limits, which will be shown in the Info Pane visible in the exposure index screen.

Setting the Exposure Index

- ▶ Select *HOME > EI* to set the exposure index.

Following options are available:

<i>160</i>	<i>400</i>	<i>1000</i>	<i>2560</i>	<i>2560 ES</i>
<i>200</i>	<i>500</i>	<i>1280</i>	<i>3200</i>	<i>3200 ES</i>
<i>250</i>	<i>640</i>	<i>1600</i>	<i>4800</i>	<i>4800 ES</i>
<i>320</i>	<i>800</i>	<i>2000</i>	<i>6400</i>	<i>6400 ES</i>



User Buttons *EI Increase* and *EI Decrease* support to quickly change the exposure index.

Info: If you change the exposure index during recording, you can only switch within normal EI or within EI with Enhanced Sensitivity, depending on which setting was selected at the start of recording.

9.5 ND Filter

The ALEXA 35 has a built-in motorized and sealed filter stage for Full Spectrum Neutral Density filters (FSND) with densities of 0.6, 1.2 and 1.8 (and an optical clear filter). In comparison to IRND filters, which have an uneven spectral behavior, or to an ordinary ND filter, which opens up at about 675 nm, the FSND filters offer a true, even light attenuation over the whole spectrum. This prevents artifacts from infrared wavelengths and the need for additional IR filters.

- ▶ Select *HOME > ND* to set the ND filter.



User Buttons *ND Increase / Decrease* support to quickly change the ND filter.

ADVICE
When the camera is switched off via its <i>POWER</i> button, the built-in ND filters move to a safe transport position at the end of the power down countdown (no glass filter visible in the gate). This position provides better protection against strong impacts to the camera during transport. When the camera is switched on again, the previously set ND filter is restored.

9.6 White Balance

White Balance (WB) is the color balance of the camera that should be matched to the color temperature of the light in use. White balance is a red-blue adjustment of the image. To adjust the green-magenta balance, use the color compensation (CC) adjustment. For example, a fluorescent source will have peaks in its spectrum that cannot be corrected with red-blue white balance alone. The CC shift can correct these peaks up to a full green or full magenta gel. One step of CC shift is equal to 035 Kodak CC values or 1/8 Rosco values.

- ▶ Select *HOME > WB* to set the white balance.
- ▶ Select a preset from the list or [add](#) a custom white balance.



User Buttons *WB Increase / Decrease* support to quickly change between white balance pre-sets.

Automatic white balance calculates the white balance based on the camera's live image and overwrites the active white balance value. The result is stored as the first entry in the WB list.

- ▶ Select *HOME > WB* and press *Auto WB*.

The monitoring outputs display an overlay indicating the area used for white balance calculation.

- ▶ Press the *Auto WB* button again within one second to execute automatic white balance. The calculated white balance is set and stored as the first entry in the white balance list.

Info: Under- or overexposed images may cause the automatic white balance to fail. Always trigger automatic white balance with properly exposed images.



User Button *Auto WB* supports to quickly execute an auto white balance.

9.7 Timecode

Timecode ensures that each frame of recorded material can be identified with a unique value and synchronized with the appropriate media, such as audio or the second camera in a multicamera application. In conjunction with other metadata, such as reel names, all recorded media retains its unique identity.

Timecode Run Mode

Rec Run timecode is often used on single camera productions that are either MOS or use a dumb slate to synchronize picture and sound. Rec Run timecode guarantees continuous timecode on all recorded data. The timecode increments only during recording, by one frame for each image generated by the sensor. Rec Run timecode also works with over- and undercranking.

Free Run timecode is often used on multi camera productions with sync sound, picture/sound timecode match and allows for easy syncing in post.

The camera can be set to timecode mode *Jam Sync*, in which it samples the timecode value once from the timecode connector and then continues counting based on its own high precision crystal clock. The timecode source can be disconnected from the camera after jamming in *Jam Sync* mode. This mode ensures stable timecode with an offset of less than one frame for each eight hours, after which the camera has to be re-jammed.

Alternatively, the camera can be set to timecode mode *Regen* (regenerate). In *Regen* mode, the camera uses the timecode value of the external timecode source. This ensures correct timecode for an infinite duration, but the timecode source must remain connected to the camera. Please note that while recording, the camera ignores external timecode and uses its internal clock to avoid potential timecode jumps, which can occur due to connection problems such as a faulty timecode cable for example.

- ▶ Select *HOME > TC > Options > Run Mode*.

Following options are available:

Rec Run	Timecode increases during recording only. The timecode value increases with every frame generated by the sensor while recording.
Free Run	Timecode increases with every new frame generated by the sensor, independently from recording.

Free Run timecode is only possible if the sensor frame rate matches the project rate. If the camera is over- or undercranking, the timecode frame rate will no longer match the sensor frame rate, and timecode values would either be duplicated or dropped. To prevent this, the camera will automatically switch to run mode *Rec Run* when the sensor frame rate is changed. When you set the sensor frame rate back to equal the project frame rate, the timecode will recall the previous free run timecode.

Timecode Mode

- ▶ Select *HOME > TC > Options > Mode*.

You have the following options:

Regen	<p>Based on the timecode run mode, the camera determines the timecode source automatically when set to <i>Regen</i>.</p> <p>If the Run Mode is set to <i>Free Run</i>, the camera regenerates timecode from the timecode connector. The timecode source must be connected to the camera permanently. Upon disconnection or loss of signal, the camera continues counting on its own, but will indicate the missing signal. When the signal is reconnected, the camera uses the value of the external signal again.</p> <p>If Run Mode is set to <i>Rec Run</i>, the camera regenerates timecode from the last clip of the recording medium by continuing seamlessly from the last active value.</p>
Preset	The camera uses its internal counter.
Jam Sync	<p>The camera samples the timecode from the timecode connector and simultaneously tunes its internal timecode clock to match the clock of the timecode source. During this procedure, the timecode display on the HOME screen, on the timecode menu screen as well as on the Status Info is blinking. Jamming has finished when the timecode display stops flashing, now the timecode source can be disconnected.</p> <p>Info: Jam-sync is not available when Timecode Run Mode is set to Rec Run.</p> <p>Info: Due to the tuning mechanism, jamming the camera might take up to 30 seconds and a timeout is issued if tuning could not be completed after 60 seconds.</p>

Setting the Timecode Manually

- ▶ Select *HOME > TC > Options > Timecode* to edit the timecode.

Info: Timecode can not be set manually when the timecode mode is set to either *Regen* or *Jam Sync*.

Timecode Count Mode

The Count Mode sets the preference for how timecode is counted when using non-integer project rates (29.97p, 59.94p).

- ▶ Select *HOME > TC > Options > Count Mode* to set the count mode.

Following options are available:

Non-Dropframe	Timecode increases with every frame without compensation, resulting in a 1,001 count for 1,000 frames.
Dropframe	Timecode values are dropped with a defined pattern (frame counts 00 and 01 of every minute, except every 10th minute) to re-adjust for the drift. A semicolon between timecode seconds and frames indicates an active dropframe timecode.

Timecode Offset

You can apply an offset to LTC input signals to compensate for timecode offsets in external devices.

- ▶ Select *HOME > TC > Options > TC Offset*.
- ▶ Adjust the timecode offset in the range of **-20** to **+20** frames.

10 Look Settings

10.1 Color Processing and Color Space

LogC4

ARRI cameras record and output images in Log C wide gamut color space. Log C images can transport all the color information and high dynamic range captured by ARRI’s camera sensors.

The LogC curve is a logarithmic encoding of the scene, which means that the relationship between the exposure measured in stops and the signal is constant over a wide range. The overall shape of the LogC curve is similar to the exposure curves of film negatives.

ARRI LogC4 is a direct successor to the prior LogC3 encoding definition in use since 2011 and was designed to optimize the encoding precision and production usability of the increased dynamic range of the ALEXA 35's ALEV4 sensor.

A LogC4 image looks different from a LogC3 image because of their different origins: the original ALEXA sensor and new ALEXA 35 sensor have a different dynamic range and therefore different demands towards a logarithmic encoding of their images.

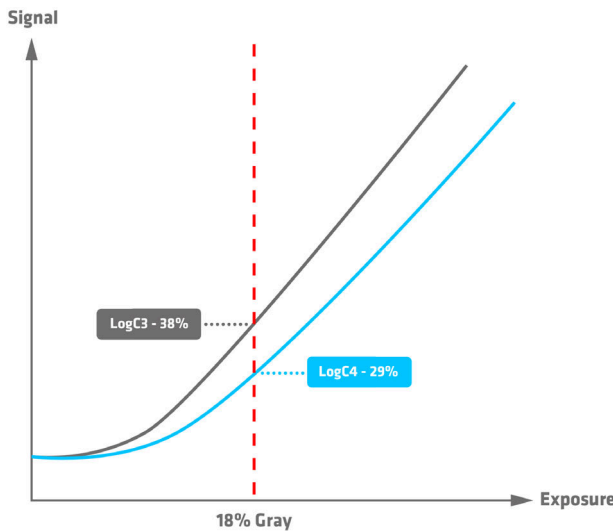

When you look at a LogC4 image, 18% gray will look darker than it used to in LogC3. Since the curve extends farther to the right in the graphic, the point of 18% gray ends up being lower on the curve.

For further information please see the ARRI LogC4 Specification, available in the download section of the [ALEXA 35 Website](#).

Log C uses what is known as scene-based encoding. The signal level increases by a fixed amount with each increase of exposure, measured in stops. This encoding, which uses an ARRI-specific wide gamut color space, is similar to files from a film scan and ideally suited to carrying image information. To correctly display Log C material on an SDR or HDR monitor (Rec 709/Rec 2020) or in a digital projection (P3), it needs to be tone-mapped and transformed into the target color space. This image conversion can be performed using a 3D Look-Up Table (3D LUT).

A set of pre-generated Look-Up Tables can be downloaded [here](#)

VF Processing

- ▶ Select *MENU > Image > Look > VF Processing* to set the processing for the EVF and the Monitor. Following options are available:

LogC4	Images are output in LogC4 on EVF and the Monitor.
Look (SDR)	The active look is applied to EVF and the Monitor in SDR.
Look (EVF: HDR, Mon: SDR)	The active look is applied to EVF in HDR. The Monitor remains in SDR mode.

 User Buttons *VF Check LogC4*, *VF Check HDR* and *VF Processing* support to quickly configure VF Processing.

SDI Processing

- ▶ Select *MENU > Image > Look > SDI 1 Processing* to set the processing for the SDI 1 output.
- ▶ Select *MENU > Image > Look > SDI 2 Processing* to set the processing for the SDI 2 output.

Following options are available:

LogC4

Images are output in LogC4 on the respective SDI output.

Wireless Video Optimized LogC4

Wireless video transmission systems use compression schemes optimized for the final image video signal, such as Rec.709. When these transmission systems are used with a log signal (darker, lower contrast) and stretched to the limits of their operating range, these compression methods may result in visual artifacts that can be exacerbated by a log signal.

Wireless Video Optimized (WVO) LogC4 is an intermediate encoding for the SDI outputs that is designed to improve monitoring image quality when transmitting LogC4 over wireless video transmitters.

At the end of the transmission, the WVO LogC4 signal needs to be decoded with a corresponding WVO LogC4 decoding LUT before applying any additional color transforms like LUTs or CDLs. This decoding LUT can be loaded directly into the wireless receiver or become the first node in your on-set color workflow:



The result of the decoding LUT is a regular LogC4 signal that can be treated in exactly the same way as having transmitted LogC4 to begin with.

Download the decode LUT from the ARRI website: [WVO decode LUT](#).

ATTENTION

Please note, that a WVO-encoded image without the decoding LUT is not compatible with any LogC4 LUT or image analysis tools, such as a false color display in a monitor. Judging images without the decoding LUT will mislead and could result in serious exposure issues.

For further information please see the [Wireless Video Optimized LogC4 White Paper](#).

Look

The active look is applied to the respective SDI output.



The applied processing is indicated by the processing icon in the status information of the respective output.



User Buttons *SDI 1 Check LogC4* and *SDI 2 Check LogC4* support to temporarily set the respective output processing to *LogC4*.

SDI Color Space

- ▶ Select *MENU > Image > Look > SDI 1 Color Space*
- ▶ Select *MENU > Image > Look > SDI 2 Color Space*

Following options are available:

REC 709 (SDR)

REC 2020 (SDR)

REC 2100 / PQ (HDR)

REC 2100 / HLG (HDR)

Info: If a look file with custom color management is used, the color space selection is limited to the color spaces specified in the look file.

10.2 Look File ALF4

The ALEXA 35 uses a new version of the ARRI Look File. While the previous version of the look file (ALF2) contains both the creative intent and the conversion to the display color space, the new ALF4 version is a log-to-log file that only contains the creative intent and can therefore be used for several target color spaces, making it possible, for example, to view SDR and HDR images with the same look at the same time. ALF4 look files can be created using the [ARRI Reference Tool](#).

The conversion of the LogC4 image to a display color space is then performed by in-camera Display Render Transforms (DRTs). These DRTs are carefully crafted conversions to the most common display color spaces (REC 709, REC 2020, REC 2100 PQ, REC 2100 HLG) that provide great looking cinematic images and are part of the REVEAL Color Science process. They can also be downloaded from the ARRI website as an ARRI LogC4 LUT package.

As of ALEXA 35 Software Update package SUP 1.2.1 and ARRI Reference Tool version 1.4.0, users have the additional option of creating an ALF4c look file with their own Display Render Transforms (DRTs).

ALEXA 35 look file workflow with ARRI Color Management
using ARRI Look File 4

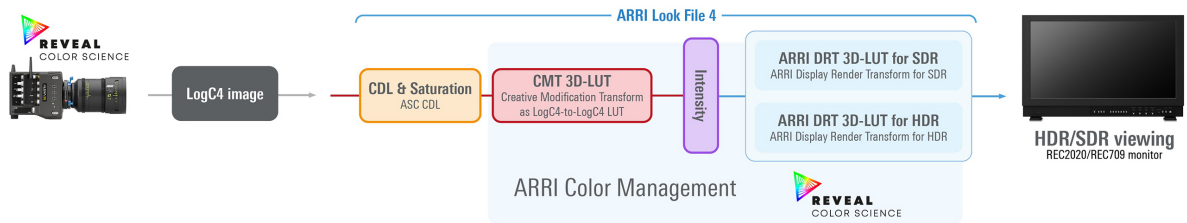

The graphic above shows the structure of a “classic” ALF4 look file. The creative intent that goes into a look file as a Log-to-Log LUT is called Creative Modification Transform (CMT). The CMT gives you full control over the image as it takes place in the LogC4/AWG4 color space. The look files provided by ARRI use the official ARRI Display Render Transforms (DRTs) for the SDI outputs (REC 709, REC 2020, REC 2100 PQ, REC 2100 HLG).

ALEXA 35 look file workflow with Custom Color Management
using ARRI Look File 4c

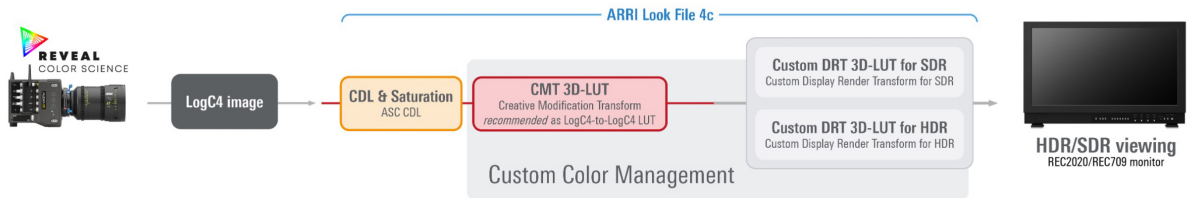

This graphic shows the structure of an ALF4c look file using a custom Display Render Transform. In addition to the creative intent, different target color spaces are defined for the SDI outputs, one for SDR and one for HDR.

An indication in the Look setting and the SDI Color Space setting shows whether you are using a Look file with ARRI or with Custom Color Management:

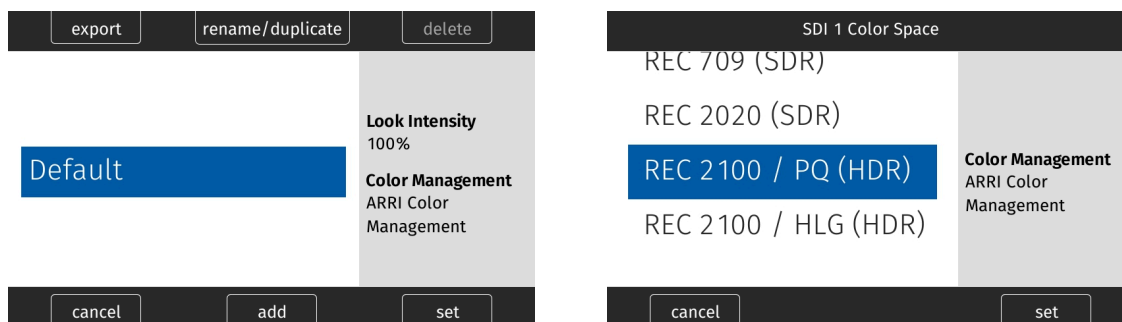

To make the look files distinguishable, look files with ARRI Color Management use the extension `.alf4` as before and look files with Custom Color Management use the extension `.alf4c`.

Info: Look Intensity can not be adjusted when using look files with custom color management.

For more information and instructions on how to create look files with custom color management, please read the corresponding white papers found in the [Technical Downloads](#) section on the ARRI website.

ADVICE
ALF1 look files are used in ALEXA Classic and ALEXA XT. ALF2 look files are used in AMIRA, ALEXA Mini, ALEXA SXT, ALEXA LF, ALEXA Mini LF and ALEXA 65. ALF4 files are used with ALEXA 35 cameras and the ALF4c files can be used with ALEXA 35 SUP 1.2.1 and later.

10.3 Setting the Look

- ▶ Select *MENU* > *Image* > *Look* > *Look*.
- ▶ Select a look from the list or [add](#) a look from an inserted USB medium or the defaults list.

ARRI Look Library

The ARRI Look Library is a collection of 87 looks that are available pre-installed in-camera. Due to their variety, the looks cater to a lot of different shooting scenarios.

The looks are numbered within nine themed groups: Application, Black-and-White, Contrast, Environment, Film, Period, Season, Special, and Tinted. In a sense, the looks can be thought of as being similar to different film stocks, each providing a unique but repeatable aesthetic when combined with the cinematographer's choice of lenses.

The ALEXA 35 includes the new LogC4 version of the ARRI Look Library. For further information about the ARRI Look Library, please visit the [ARRI Look Library Microsite](#) or the [ARRI Look Library FAQs](#).

- ▶ Select *MENU* > *Image* > *Look* > *Look* > *Add* > *Look Lib*.
- ▶ Select a look from the list and press *IMPORT* to add the look to the installed looks list.
- ▶ Import further looks from the Look Library or press *CANCEL* to exit.

Look Duplicate and Rename

- ▶ Select *MENU* > *Image* > *Look* > *Look*.
- ▶ Select a look from the list and press *DUPLICATE* / *RENAME*.
- ▶ Enter a new name and press *SET* to rename the look, or press *DUPLICATE* and then *SET* to duplicate the look.

Info: The Default look can not be renamed.

Look Export

Look files can be exported to the USB medium to be sent to post production or to be imported on other cameras.

- ▶ Insert the USB medium into the camera.
- ▶ Select *MENU > Image > Look > Look*.
- ▶ Select a look from the list and press *EXPORT*.

The look file is stored in folder *ARRI/ALEXA35/LOOKFILES* on the USB medium.

10.4 Look Intensity

The Look Intensity adjusts the level of look application to the LogC4 image, where 100% translates to a fully applied look and 0% to a plain LogC4 image. The look intensity is stored as a metadata in the ALF4 look file. When the look is loaded, the camera reads the metadata and applies the look intensity accordingly. In this way, the look intensity of a look can be changed as often as desired.

- ▶ Select *MENU > Image > Look > Look Intensity* to set the look intensity of the active look between 10% and 100%.

Info: The active look is stored in the clip metadata. Here, however, the set intensity is “burned” into the look file with a recalculated LUT.

11 ARRI Textures

ARRI digital cameras have always had a ‘texture’ setting that is programmed into the way the sensor captures images and subsequently bakes them (the images) into the ARRIRAW and ProRes outputs. That texture setting, comprising many carefully balanced parameters, determines the amount of grain in the image and the character of that grain. It also determines the amount of contrast at different levels of detail in the image, which defines the perceived sharpness (technically called the MTF curve).

Up until now, ARRI cameras have been pre-programmed with a single, unchangeable texture setting that is optimized for the widest possible range of shooting scenarios. The ALEXA 35 gives cinematographers the option to go beyond this default texture setting and choose from an evolving menu of ARRI Textures, each designed for specific applications. This unique feature allows cinematographers to fundamentally alter the way in which the camera records images.

Behind the three main texture characteristics of grain volume, grain character, and perceived sharpness, are around 30 image processing settings that occur early in the imaging chain inside the camera, even before the ARRIRAW image is created. Since many of these steps interact with each other in complex ways, any user interface providing full access to all settings would be prohibitively complicated. Instead, we decided to collect sensible combinations of settings into individual ARRI Texture files. The camera comes with several ARRI Textures pre-installed, which have been designed in close cooperation with selected cinematographers. ARRI Textures are applied to the image before the exposure index setting, which controls the camera’s sensitivity, and before the ARRI Look File processing, which controls color. Since ARRI Textures are settings for image processing steps that occur before the ARRIRAW image is created in the camera, ARRI Textures are always baked into ARRIRAW and ProRes.

If a texture other than the K445 Default texture is to be used, it is very important for ARRI Textures to be tested during preproduction, in the highest quality viewing environment possible. An ARRI Texture that looks right in a DI suite or on a high end display will be very subtle or perhaps even invisible when viewed in the camera’s viewfinder or on the camera’s SDI outputs. It is for this reason that we recommend testing ARRI Textures in preproduction and viewing them on a large (at least 30-inch) high quality UHD 4K monitor, ideally in HDR. Best practice is to view the images using an HDR 4K grading display.

If a texture other than the K445 Default texture is to be used, it is very important for ARRI Textures to be tested during preproduction, in the highest-quality viewing environment possible. An ARRI Texture that looks right in a DI suite or on a high-end display will be very subtle or perhaps even invisible when viewed in the camera’s viewfinder or on a small regular SDR display connected to the camera’s SDI output. It is for this reason that we recommend testing ARRI Textures in preproduction and viewing them on a large (at least 30-inch) high-quality UHD 4K monitor, ideally in HDR. Best practice is to view the images using an HDR 4K grading display.

Naming Scheme

ARRI Texture names consist of two parts: a technical summary of the texture and a more memorable word or words that describe the texture. While ARRI Textures represent about 30 image processing settings, we have distilled those to four important attributes for the technical summary, so you can quickly tell what to expect.

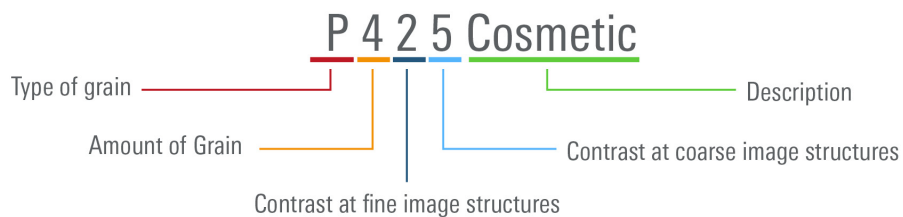

Type of grain	The type of grain can vary in quite complex ways, e.g. more or less color, fine/coarse etc. The grain of the default Texture K445 Default complies with a letter in the middle of the alphabet. The bigger the variations in color, size etc. are of this default grain, the further away is the letter of another ARRI texture. The closer the letters are in the alphabet, the more similar is the impression regarding the type of grain.
Amount of grain	A number indicating the amount of grain. The higher the number, the more grain there is (0 to 9).
Contrast at fine image structures	This number indicates the amount of contrast for fine image structures (high spatial frequencies). The higher the number, the higher the contrast (0 to 9).
Contrast at coarse image structures	This number indicates the amount of contrast for coarse image structures (low spatial frequencies). The higher the number, the higher the contrast (0 to 9).
Description	A descriptive name of the texture.

- Select *MENU > Image > Texture > Texture* to set the Texture.

Following options are available:

K445 Default	The K445 Default texture is designed to work well for all subject matters and settings, while making the most of the camera's cinematic strengths. It is forgiving on skin, but also renders images with exceptional clarity and detail, which makes it also a perfect texture for green screen shots. This is also the texture to use when shooting with ALEXA 35 and previous ARRI digital cameras, as it closely matches those cameras textures. Perfect for all EI settings.
P425 Cosmetic	A softer texture, very close to the cinematic K445 Default, especially recommended for rendering skin tones. More forgiving on skin while keeping structures and highlights pronounced. Low to moderate grain. Perfect for all EI settings.
G522 Soft Nostalgic	A grainy texture with a subtle vintage feel, designed to render some unsaturated grain and a softer character. Little softer vintage Texture than G733 Nostalgic. Perfect for all EI settings.
G733 Nostalgic	A grainy texture with a vintage feel, designed to render a lot of grain and a soft character. The unsaturated grain type was created based on direct feedback from cinematographers. Perfect for all EI settings.
F567 Clarity	A texture designed to work for any kind of footage, with increased sharpness and detail compared to the K445 Default texture. The Clarity textures are a perfect choice for landscape shots. Works best for low to mid EI settings.
F578 High Clarity	A texture designed to work for any kind of footage, with even more detail compared to the K445 Default texture. The Clarity textures are a perfect choice for landscape shots. Works best for low to mid EI settings.
L345 Shadow	A texture based on the K445 Default texture, with lower noise and grain optimized for images with a lot of dark content. The visible grain emulates the look of grain in the toe of color negative film and is more pleasing in darker scenes. Works best for mid to high EI settings.

H457 Deep Shadow

A texture designed for the darkest shots. This texture has low noise, and the remaining grain is less saturated. It has higher clarity and even more shadow detail retention than the L345 Shadow texture. Works best for mid to high EI settings.

The applied Texture is indicated by the texture icon in the status information of EVF and SDI 1/2.

12 Recording

12.1 Recording Medium

⚠ CAUTION



Hot Surfaces on Recording Media

During extended operation, high data rates and/or operation at high ambient temperatures, the recording media in the camera can get hot to the touch and can cause pain or even burns if held for too long directly after removal.

- ▶ Do not handle the recording media for longer than three seconds and remove it quickly but carefully.
- ▶ Consider to wear protective gloves when removing the recording media or allow it to cool down beforehand.
- ▶ Do not put any labels or adhesive tape on the recording media (especially the side facing the camera body). The recording media must have full contact to the thermal surface inside the camera to ensure proper heat conduction.

ADVICE



Recording Media Damage due to improper Handling

Damage to the Recording Media or Loss of Data.

- ▶ Always insert the recording media as described in this document.
- ▶ Keep the media door closed to prevent dirt and moisture from entering the camera.
- ▶ Do not put any labels or adhesive tape on the recording media. The metal surface is used for cooling. A hot medium can have reduced performance. The plastic surface can easily be broken off when a label is removed.
- ▶ Never remove a drive while recording - this may damage the recorded clip.
- ▶ If the recording process is interrupted by power loss or drive removal, transfer all the data from the drive and format it before using it again.
- ▶ While we do everything we can to assure reliable functioning of different recording media such as Codex Compact Drives, and while the mean time before failure (mtbf) for drives is excellent, a failure that results in loss of data may occur at any time. Therefore, you are obliged to implement and maintain at any time adequate and necessary data security measures and back up drive content as soon as possible. ARRI assumes or accepts no liability or responsibility for data loss or data corruption, or any other damages, loss or harm due to malfunction of recording drives.

ADVICE

A maximum of 400 clips can be recorded on a drive. When the maximum of 400 clips is reached, the recording media will be declared as full and further recording onto the media is not possible.

Codex Compact Drives

The Codex Compact Drive is designed to support the demands of creative professionals working with the ALEXA Mini LF and the ALEXA 35. It offers robust mechanical protection, efficient cooling and a reliable connector for the integrated, high speed flash memory.

Compact Drives are currently available with 1 TB (960 GB usable) and 2 TB (1920 GB usable) capacity. The 2 TB drive offers about double speed for all ARRIRAW formats on ALEXA 35. There is no advantage other than capacity for the ALEXA Mini LF. At 24 fps ARRIRAW 4.6K 3:2 Open Gate, the recording time is a little over 25/50 min. At 24 fps Apple ProRes 4444 4K 16:9, the recording time is a little over 90/180 min.

The camera records its data to the ARRI UDF file system which is accessible for operating systems without the need for special software. Depending on performance vs budget requirements, you can choose between a USB-C Reader or a Thunderbolt 3 Dock. Mac users who own a SXR Capture Drive Dock can get a Compact Drive Adapter, which combines high performance with lower pricing.

Recorded material can be accessed directly with the USB-C Codex Compact Drive Reader, the Compact Drive Dock or an SXR Capture Drive Dock when it is equipped with a Compact Drive Adapter.

Compact Drives are specified for a temperature range from 0 °C to 70 °C (32 °F to 158 °F). When inserting the drive with a temperature below 0 °C, the camera will go into an alert state and prevent access to the drive until such time that the media reaches its minimum operational temperature. Once the media is within specified temperature range, the camera will complete loading the media and resume regular operation.

Inserting the Codex Compact Drive

- ▶ To access the media slot, slide the media door release downwards so that the spring loaded media door jumps open.
- ▶ With the contact pins first and the Codex label side facing out (away from the camera body), gently insert the drive into the slot until it locks.
- ▶ Gently close the media door. Do not force the door closed if the drive is not fully inserted. Do not force the drive into the slot in wrong orientation - the contacts could be damaged.

Removing the Codex Compact Drive

Compact Drives do not have to be unmounted prior to removal, they can be removed whenever the drive LED shows solid green.

- ▶ Slide the media door release downwards so that the spring loaded media door jumps open.
- ▶ Grab the drive with your thumb and index finger and gently pull it out the media slot.

Erasing the Recording Medium

ADVICE
<p>When erasing the recording medium, all data is completely erased and cannot be recovered afterwards. Make sure that all data has been copied from the media before erasing.</p> <p>Do not disconnect the camera from the power supply or turn it off while erasing.</p> <p>Do not remove the recording medium while erasing.</p>

Before using a Codex Compact Drive with the camera, it must be erased in the camera to create the required file system. Codex Capture drives are initialized with the UDF file system, which is read only for computers, and it is named ARRI_UDF until the first clip is recorded. Once a clip has been recorded, the name changes to the camera index letter and current reel number.

- ▶ Select *MENU > Media > Erase Media*.

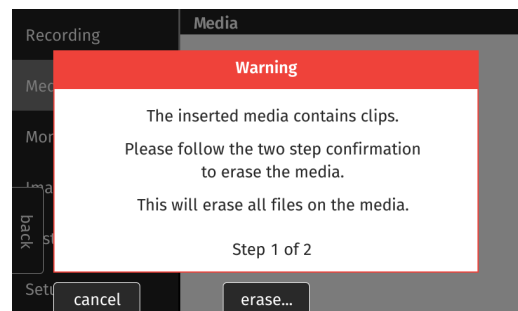
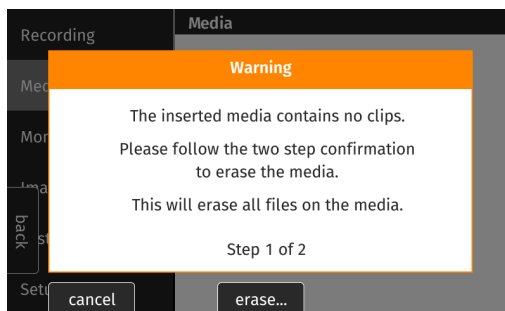

The camera informs you whether there are clips on the medium (red dialogue) or not (orange dialogue). This information only refers to clips that were recorded with an ALEXA 35 or an ALEXA Mini LF, but not to other files that the user has saved on the medium.

- ▶ Press *ERASE* twice to start erasing the medium, or press *CANCEL* to cancel.
- or
- ▶ Select *Side Display > Settings > Erase Media*.
- ▶ Press *YES* to start erasing the medium, press *NO* to cancel.

Compact Drive LED States

LED State	Media State
Solid Green	Drive is in standby, ready to record and safe to remove.
Solid Red	Read/write access during Playback or Recording. Do not remove the drive. Info: As recording is stopped, it takes a few seconds to finalize the recorded clip. During this time, the drive should not be removed.
Blue flashing	Drive is being loaded or unloaded.
Red flashing	Drive error, see <i>MENU > Alerts</i> for details.
Off	Drive cannot be accessed. Please try reinserting the drive. If the problem persists, check the drive state with Codex Device Manager.

Media Info

- ▶ Select *MENU > Info > Media Info* for additional information on the inserted medium.

12.2 Recording Codec

MXF (Material eXchange Format)

Both ARRIRAW and Apple ProRes files are recorded in an MXF (Material eXchange Format) container. An MXF container file can “wrap” different types of video and audio material along with associated metadata. The internal structure of these files is defined by the Operational Patterns (OP). Our cameras create MXF files with OP1a structure, which packages picture, sound and metadata into a single file. This structure is ideal for both camera acquisition and archiving, since audio, video and metadata is always kept together and virtually no data gets lost if recording is unexpectedly interrupted. OP1a also is a streaming format, which means that even incomplete files can be repaired and accessed up to the last recorded frame.

ARRIRAW

ARRIRAW data delivers unencrypted, uncompressed and uncompromised image quality. It offers the highest achievable resolution, the camera's natural color response and exposure latitude as uncompressed and unprocessed sensor data. ARRIRAW images have only one channel. A color reconstruction algorithm calculates the missing components of each pixel based on the type and position of the array of colored filters (Bayer pattern) on the camera sensor.

ARRIRAW de-bayering is available through the ARRI Imaging SDK only, which is implemented in the ARRI Reference Tool (ART) and most of the major post production tools for dailies processing and mastering.

The camera will automatically calculate a CRC32C checksum for the image data inside each ARRIRAW frame. This checksum is recorded as part of the image header and can be used by software like the ARRI Reference Tool, to verify that the ARRIRAW image content has not changed during any copy step. Note that this checksum does not validate the entire file, only the image data. Note that during the download from the Compact Drive to a computer or afterwards it is possible to reduce the size of ARRIRAW files by up to 40% using Codex High Density Encoding (HDE) technology with the ARRIRAW HDE Transcoder app.

Apple ProRes

Recording in Apple ProRes is a cost efficient alternative to shooting ARRIRAW, as it requires less storage space and no further processing in post.

Info: Apple ProRes is a variable bit rate (VBR) codec. Depending on the content of your images the remaining recording time on the recording media can be shorter or longer than indicated by the camera.

- ▶ *Select Menu > Recording > Recording Codec* to set the desired recording codec.

Following options are available:

Apple ProRes 422 HQ	12-bit LogC4 YCbCr	Use for high quality TV production. Suitable for creative color correction.
Apple ProRes 4444	12-bit LogC4 YCbCr	Use for high quality TV and cinema production. Very suitable for creative color correction and visual effects work such as pulling mattes.
Apple ProRes 4444 XQ	12-bit LogC4 YCbCr	The ideal choice for productions that are shooting for premium image quality, are looking for extreme color grading and want to preserve the superior tonal range of ARRI's Log C signal.
ARRIRAW	13 bit log	Use for cinema production, visual effects and high quality TV. It is the best format for creative color correction, visual effects work and archiving.

Info: Changing between ARRIRAW and Apple ProRes may require a camera reboot.

12.3 Sensor Mode & Recording Resolution

The sensor mode determines the size of the area on the sensor that is read out. This affects the maximum possible frame rate, the maximum data rate, and which lenses can be used. The sensor mode naming is composed of the number of horizontal photo sites in “K” (a thousand) and the aspect ratio used on the sensor.

The recording resolution is the resolution of the file that is being recorded in camera. Most of the time the number of photo sites read from the sensor and the number of pixels recorded are identical, in some other cases, as for instance in 4K 16:9 - 2K, the number of photo sites read out from the sensor is larger than the number of pixels recorded into the file.

- ▶ Select *Menu > Recording > Sensor Mode* to select the desired Sensor Mode.
- ▶ Select *Menu > Recording > Recording Resolution* to select the associated Recording Resolution.

Info: Changing between Sensor Modes may require a camera reboot.

Info: The Recording Resolution is set automatically if a Sensor Mode offers only one associated Recording Resolution.

4.6K 3:2 Open Gate

4.6K 3:2 Open Gate provides maximum image quality, resolution, and flexibility in post for many spherical and anamorphic lenses in an image area slightly larger than traditional Super 35 film specifications.

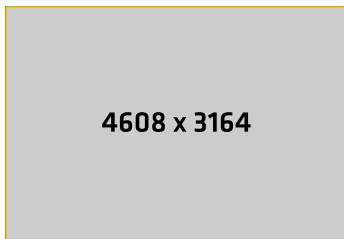

Active Image Area (Photo sites)
4608 x 3164

Active Image Area (Dimensions)
28.0 x 19.2 mm / 1.102 x 0.756"

Image Circle Ø
33.9 mm / 1.337"

Recording Resolutions

ARRIRAW 4.6K (4608 x 3164)

ProRes 4.6K (4608 x 3164)

4.6K 16:9

Full sensor width recording in a 16:9 format that suits many spherical Super 35 and all large format lenses, with room for flexibility in post. Lower data rate than 4.6K 3.2 Open Gate.

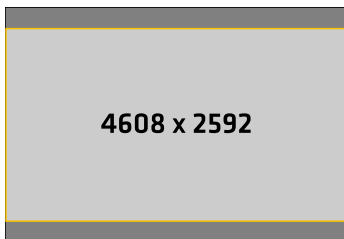

Active Image Area (Photo sites)
4608 x 2592

Active Image Area (Dimensions)
28.0 x 15.7 mm / 1.102 x 0.618"

Image Circle Ø
32.1 mm / 1.264"

Recording Resolutions

ARRIRAW 4.6K (4608 x 2592)

ProRes 4K (4096 x 2304)

4K 16:9

4K 16:9 mimics the traditional spherical Super 35 film format for maximum lens compatibility. Multiple in-camera downsampling options provide lower data rates.



Active Image Area (Photo sites)

4096 x 2304

Active Image Area (Dimensions)

24.9 x 14.0 mm / 0.980 x 0.551"

Image Circle Ø

28.6 mm / 1.125"

Recording Resolutions

ARRIRAW 4K (4096 x 2304)

ProRes 4K (4096 x 2304)
UHD (3840 x 2160)
2K (2048 x 1152)
HD (1920 x 1080)

4K 2:1

4K 2:1 was designed for shooting with all spherical Super 35 and large format lenses for a target deliverable of 2:1, fulfilling 4K mandates.

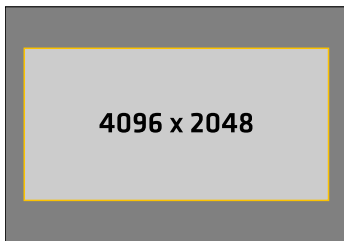

Active Image Area (Photo sites)

4096 x 2048

Active Image Area (Dimensions)

24.9 x 12.4 mm / 0.980 x 0.490"

Image Circle Ø

27.8 mm / 1.095"

Recording Resolutions

ARRIRAW 4K (4096 x 2048)

ProRes 4K (4096 x 2048)

3.8K 16:9

For projects using spherical lenses for a 16:9 UHD deliverable. Smaller sensor area than sensor mode '4.6K 16:9' ensures that most S35 format lenses cover. Lower data rate and higher fps than sensor modes '4.6K 3:2 Open Gate' and '4.6K 16:9'.



Active Image Area (Photo sites)

3840 x 2160

Active Image Area (Dimensions)

23.3 x 13.1 mm / 0.918" x 0.516"

Image Circle Ø

26.8 mm / 1.054"

Recording Resolutions

ARRIRAW UHD (3840 x 2160)

3.3K 6:5

For projects using 2x anamorphic Super 35 lenses for a target deliverable of 2.39:1. Negates necessity of cropping 4:3 footage and fulfills 4K mandates.

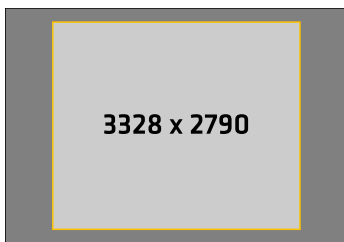

Active Image Area (Photo sites)

3328 x 2790

Active Image Area (Dimensions)

20.2 x 16.9 mm / 0.796 x 0.693"

Image Circle Ø

26.4 mm / 1.039"

Recording Resolutions

ARRIRAW 3.3K (3328 x 2790)

ProRes 3.3K (3328 x 2790)
4K 2.39:1 Ana. 2x
(4096 x 1716)

3K 1:1

3K 1:1 was designed for shooting with 2x anamorphic lenses for a target deliverable of 2:1, fulfilling 4K mandates.

**Active Image Area** (Photo sites)

3072 x 3072

Active Image Area (Dimensions)

18.7 x 18.7 mm / 0.737 x 0.737"

Image Circle Ø

26.4 mm / 1.041"

Recording Resolutions**ARRIRAW** 3K (3072 x 3072)**ProRes** 3K (3072 x 3072)

3.8K 2:1 Ana. 2x

(3840 x 1920)

2.7K 8:9

For projects shooting with 2x anamorphic lenses for a target deliverable of 16:9, fulfilling 4K mandates. Desqueeze applied in-camera.

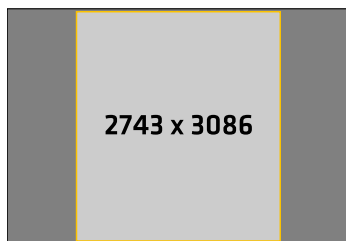
**Active Image Area** (Photo sites)

2743 x 3086

Active Image Area (Dimensions)

16.7 x 18.8 mm / 0.656 x 0.738"

Image Circle Ø

25.1 mm / 0.988"

Recording Resolutions**ProRes** UHD 16:9 Ana. 2x

(3840 x 2160)

2K 16:9 S16

2K 16:9 S16 mimics the traditional Super 16 format for use with Super 16 lenses or as an in-camera center crop.

**Active Image Area** (Photo sites)

2048 x 1152

Active Image Area (Dimensions)

12.4 x 7.0 mm / 0.490 x 0.276"

Image Circle Ø

14.2 mm / 0.561"

Recording Resolutions**ProRes** 2K (2048 x 1152)

For additional information please see ["Data Rates, Recording Times and Max. FPS", page 122.](#)

12.4 Starting Recording

The camera supports various ways to start and stop recording. Recording can be started and stopped by

- The *REC* button on the camera body, the MVF-2 and ARRI hand units such as the WCU-4 and Hi-5
- The Camera Companion App
- The Remote Switch RS-4, connected to the camera's RS connector
- Through WiFi / Ethernet, using the Web Remote or applications communicating via CAP (Camera Access Protocol)



User button *Record Start/Stop* supports to start and stop recording.

User buttons can be assigned to e.g. the ARRI Master Grips, the Operator Control Unit OCU-1 and the General Purpose I/O Box

Starting recording returns the MVF-2 as well as the side display to their HOME screen and disables access to sensor fps, timecode, shutter, auto white balance, erase media, playback and most menu settings.

12.5 Prerecording

Prerecording writes images into an internal ring buffer for up to 20 seconds in real time instead of recording them directly to the recording medium. When regular recording starts, the buffered images are written to the recorded clip. This allows unpredictable events to be captured without wasting media capacity. The maximum available duration of Prerecording is determined by the set combination of sensor frame rate, recording codec and sensor mode, but can also be set by the user within these limits.



Prerecording can only be started and stopped using a user button assigned with *Prerecording*.

- ▶ Select *MENU > User Buttons* and assign *Prerecording* to the desired button.
- ▶ Press the user button to start Prerecording.
- ▶ Press the user button again to end Prerecording or press the *REC* button to start regular recording.

Info: When ending Prerecording, the ring buffer is cleared.

Info: While Prerecording is active, timecode, shutter, sensor fps, auto white balance, erase media, playback and most menu settings cannot be accessed.

Setting the Prerecording Duration

- ▶ Select *MENU > Recording > Prerecording max. Duration* and set the maximum duration used for Prerecording in a range from **1** to **20** seconds.

The available Prerecording duration depends on the set Codec, Sensor Mode and Recording Resolution:

Sensor Mode	Recording Resolution	Codec	Prerec Duration @ 24fps
4.6K 3:2 Open Gate	4.6K (4608 x 3164)	ARRIRAW	2.8 s
		Apple ProRes 422 HQ	8.5 s
		Apple ProRes 4444	5.6 s
		Apple ProRes 4444 XQ	3.6 s

Sensor Mode	Recording Resolution	Codec	Prerec Duration @ 24fps
4.6K 16:9	4.6K (4608 x 2592)	ARRIRAW	3.5 s
	4K (4096 x 2304)	Apple 422 HQ	12.7 s
		Apple 4444	8.8 s
Apple 4444 XQ		5.8 s	
4K 16:9	4K (4096 x 2304)	ARRIRAW	4.6 s
		Apple 422 HQ	12.7 s
		Apple 4444	8.8 s
	UHD (3840 x 2160)	Apple 4444 XQ	5.8 s
		Apple 422 HQ	14.2 s
		Apple 4444	9.9 s
2K (2048 x 1152)	Apple 4444 XQ	6.6 s	
	Apple 422 HQ	20.0 s	
	Apple 4444	20.0 s	
HD (1920 x 1080)	Apple 4444 XQ	20.0 s	
	Apple 422 HQ	20.0 s	
	Apple 4444	20.0 s	
4K 2:1	4K (4096 x 2048)	ARRIRAW	5.2 s
		Apple 422 HQ	14.0 s
		Apple 4444	9.8 s
3.8K 16:9	UHD (3840 x 2160)	Apple 4444 XQ	6.5 s
		ARRIRAW	5.3 s
		Apple 422 HQ	12.9 s
3.3K 6:5	3.3K (3328 x 2790)	Apple 4444	8.9 s
		Apple 4444 XQ	5.9 s
		ARRIRAW	4.7 s
4K 2.39:1 Ana 2x	4K 2.39:1 Ana 2x	Apple 422 HQ	16.3 s
		Apple 4444	11.5 s
		Apple 4444 XQ	7.8 s
3K 1:1	3K (3072 x 3072)	ARRIRAW	4.6 s
		Apple 422 HQ	12.7 s
		Apple 4444	8.8 s
	3.8K 2:1 Ana 2x	Apple 4444 XQ	5.8 s
		Apple 422 HQ	15.6 s
		Apple 4444	11.0 s
Apple 4444 XQ	Apple 4444 XQ	7.5 s	

Sensor Mode	Recording Resolution	Codec	Prerec Duration @ 24fps
2.7K 8:9	UHD 16:9 Ana 2x	Apple 422 HQ	14.2 s
		Apple 4444	9.9 s
		Apple 4444 XQ	6.6 s
2K 16:9 S16	2K (2048 x 1152)	Apple 422 HQ	20.0 s
		Apple 4444	
		Apple 4444 XQ	

12.6 Clip Naming Scheme

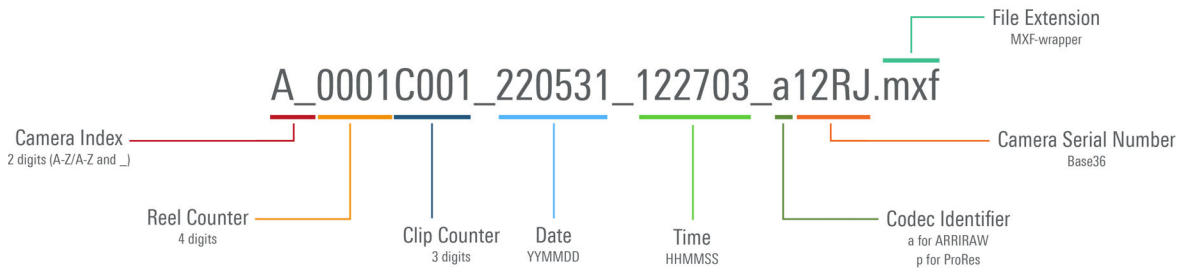

Camera Index	The camera index consists of two characters, A-Z + _. User assignable, it should match the camera unit. For example, the camera index A_ can be assigned to the A camera, and B_ to the B camera etc.
Reel Counter	4 characters, 0001-9999. Automatically increments for each blank recording medium. The user can change the counter for the next reel. This should only be done under special circumstances, such as after changing the camera body in the middle of a shoot.
Clip Counter	One prefix, fixed to C, to separate the reel counter from the clip counter. 3 characters, 001-400. Automatically increments each time a clip is recorded.
Date	Current system date (YYMMDD) as set in <i>MENU > System > System Time + Date</i> , separated from the other naming components by an underscore.
Time	Current system time (HHMMSS) as set in <i>MENU > System > System Time + Date</i> , separated from the other naming components by underscore.
Codec Identifier	One character, identifies the clip codec (a = ARRIRAW, p = Apple ProRes).
Camera ID	The camera serial number encoded in 4 letters Base 36 (0-9, A-Z). 12RJ translates into decimal serial number 50239.
File Extension	All clips are written as MXF files.

For more information on the Camera Index and the Next Reel Count please see ["Project Settings", page 37](#).

12.7 Audio Recording

The camera supports to record up to 4 channels of linear PCM audio (24 bit, 48 kHz).

Audio Inputs

The AUDIO connector (1) is located on the right side of the camera. It is a two channel +24 dBu line level audio input with additional 12 V power output to supply microphone preamplifiers. This is the same 6-pin connector used on the ALEXA Mini LF. Use the ALEXA Mini LF Audio connector with cable (K2.0023988) to connect audio sources.

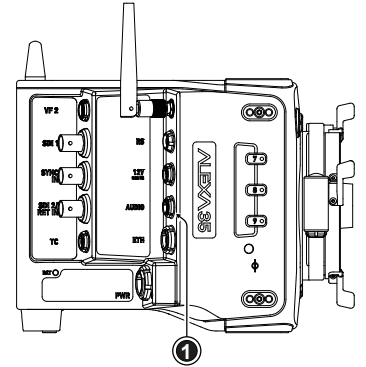

The dual gain internal microphones (2 = Internal Mic R, 3 = Internal Mic L, seen from operator point of view) are located at the camera front and can be used to record a reference track, sometimes called a “scratch track”. Some software tools can synchronize the master sound with the image by using the reference track. The gain of the internal microphones is fixed, with the left microphone (3) having a gain of +18 dB and the right microphone (2) a gain of 0 dB, to cover a wide audio level range.

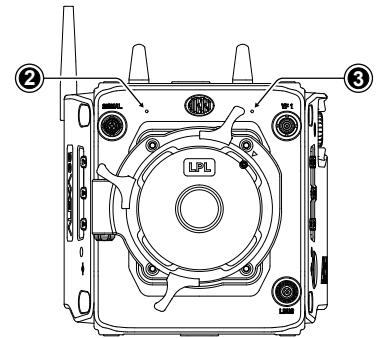

The additionally available Audio Extension Module AEM-1 supports the use of either two balanced Mic/Line inputs (1) with switchable +48 V phantom power, or one AES3 input (2). It is docked directly to the rear interface of the camera. For more information please refer to the user manual of the module.

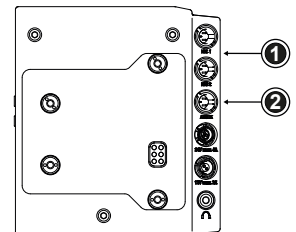

Audio Outputs

Active audio channels are embedded with a 1 to 1 channel mapping in the SDI stream and also output via the headphone output of the MVF-2.

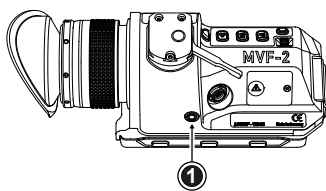

The headphones out (1) on the MVF-2 is a 3.5 mm TRS connector (headphone jack) which outputs all four audio channels with a maximum power of 2.5 dBm. The camera's headphone routing allows configuring which channels are output on the connector.

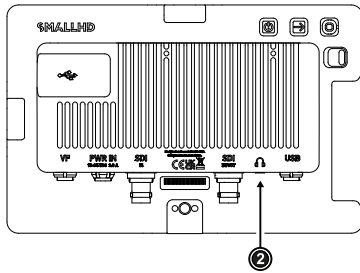

The headphones out (2) on the CCM-1 is a 3.5 mm TRS connector (headphone jack) which outputs all four audio channels with a maximum power of 2.5 dBm. The camera's headphone routing allows configuring which channels are output on the connector.

Activation of Audio Recording

- ▶ Select *MENU > Recording > Audio Recording > Audio Recording* to enable/disable audio recording. Enabled audio recording is indicated through the audio meters displayed on the HOME screen as well as in the Status Info. The meters show the current level of the channel signal in dBFS. Audio recording is temporarily disabled if the frame rate of the sensor does not match the frame rate of the project.

Routing of Channels

- ▶ Select *MENU > Recording > Audio Recording > Channel 1/2/3/4 Source* to set the input source for each channel.

Following options are available:

- None** No source is assigned to the channel. The channel is not written to the recorded file if subsequent channels (by channel no.) also do not have a source assigned to them.
- Line In L** The left channel of the camera's AUDIO input is assigned to the channel.
- Line In R** The right channel of the camera's AUDIO input is assigned to the channel.
- AEM-1 L** The left channel from the Audio Extension Module AEM-1 is assigned to the channel.
- AEM-1 R** The right channel from the Audio Extension Module AEM-1 is assigned to the channel.
- Internal Mic L** The left internal microphone is assigned to the channel. This microphone uses a fixed gain of +18dB.
- Internal Mic R** The right internal microphone is assigned to the channel. This microphone uses a fixed gain of 0dB.



An icon on the HOME screen and in the Status Info indicates active internal microphones.



The icon is crossed out when the internal microphones are muted.

Setting the Channel Control

- ▶ Select *MENU > Recording > Audio Recording > Channel 1/2/3/4 Control* to set the gain control for each channel which has either *Line In L* or *Line In R* assigned as source.

Following options are available:

- Manual Gain** Allows the user to manually adjust the gain of the input signal on the channel to reach a desired level.
- Manual Gain + Limiter** A limiter prevents the signal from clipping if the input signal level combined with the set gain results in signal levels exceeding -6 dBFS.
- Auto Gain** Matches a 0 dBu input signal to -6 dBFS. This setting leaves enough headroom for recording and avoids audio clipping. Audio levels can not be adjusted by the user.

Headphones Routing and Headphones Volume

- ▶ Select *MENU > Recording > Audio Recording > VF Headphone Routing > Channel 1/2/3/4* to configure the routing of audio channels to the headphones.

Following options are available:

- Off** The audio channel is not output on the headphones.
- L** The audio channel is output on headphones left.
- L + R** The audio channel is output on headphones left and right.
- R** The audio channel is output on headphones right.

- ▶ Select *MENU > Recording > Audio Recording > VF Headphone Volume* to adjust the volume of the headphones connected to the MVF-2.

Gain Adjustment

- ▶ Select *MENU > Recording > Audio Recording > Gain Levels* to adjust the gain in steps of 1.0 dB for each channel which has either *Line In L* or *Line In R* assigned as source.

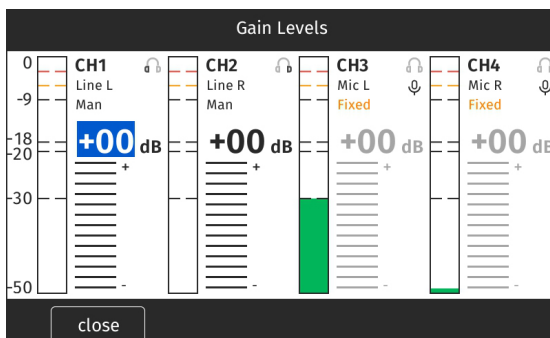

- ▶ Rotate the jogwheel or use the touch slider to set the gain of the first channel. Then press the jog wheel to move to the next channel or tap a channel to select it. Channels whose gain is not adjustable are skipped and displayed as "fixed". The blue cursor indicates the selected channel.
- ▶ Press *CLOSE* to save the changes and exit the screen.

Info: Gain adjustment is not available for channels to which the internal microphones or the Audio Extension Module AEM-1 are assigned as source. The internal microphones use a fixed, non-adjustable gain, the gain of the signals applied to the AEM-1 must be set on the AEM-1 itself.

Reference Tone

A 1 kHz sine reference tone can be output on the SDI outputs and the headphone outputs of MVF-2 and AEM-1. If a recording is started during this time, the test tone is also recorded in all active audio channels of the clip.

- ▶ Select *MENU > Recording > Audio Recording > Reference Tone*.

Following options are available:

- Off** **-9 dBFS** **-18 dBFS** **-20 dBFS**

Info: The reference tone can only be activated when audio recording is enabled.

- User Buttons *Audio Ch1 Increase / Decrease* and *Audio Ch2 Increase / Decrease* support to quickly adjust gain of channels 1 and 2.
- User Button *Audio Mute int. Mic* mutes the internal microphones.
- User Button *Audio Solo* allows each channel to be monitored individually while the other channels are muted.



12.8 Rec Beeper and Tally

- ▶ Select *MENU > Recording > Rec Beeper / Tally*.

Following options are available:

<i>Rec Start Beeper</i>	The camera gives an acoustic indication at start of recording.
<i>Rec Stop Beeper</i>	The camera gives an acoustic indication at stop of recording.
<i>Media Full Beeper</i>	The camera gives an acoustic indication for stopping recording due to full recording medium. For better distinction, a different sound pattern than the start/stop beeper is used.
<i>Tally MVF-2</i>	Enables the tally light on the MVF-2.

13 Playback

In-camera playback plays back the clips on the recording media at their project frame rate and is output to EVF, Monitor, SDI 1 and SDI 2. Playback can be controlled from a variety of locations such as the MVF-2, the camera's side display, the Web Remote, the Camera Companion App or hand units such as the Hi5.

Playback Control via MVF-2

- ▶ Press and hold the *PLAY* button (1) of the MVF-2 for one second to start playback.
- ▶ Toggle between play and pause by briefly pressing the *PLAY* button.
- ▶ To exit playback press and hold the *PLAY* button for one second.

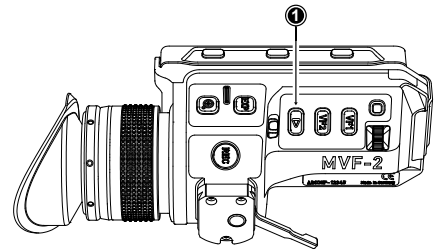

The playback screen of the MVF-2 offers the following controls:

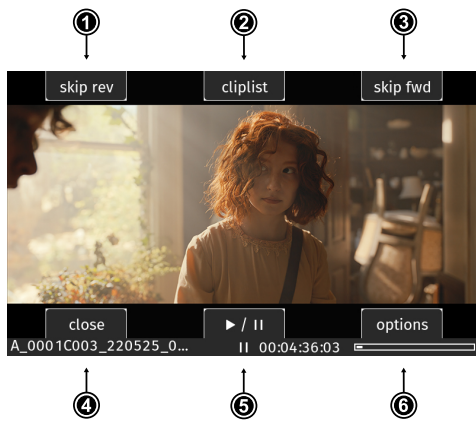

- 1 *Skip reverse* Loads the previous clip from the cliplist.
- 2 *Cliplist* Select another clip for playback from a list of all clips on the recording medium.
- 3 *Skip forward* Loads the next clip from the cliplist.
- 4 *Close* Exits playback.
- 5 *Play/pause* Toggles between play and pause.
- 6 *Options* Allows setting the clip end action.

Play/pause can also be toggled by pressing the *PLAY* button on the MVF-2 or by pressing the jogwheel. While playback is paused, rotate the jogwheel to scroll through the clip frame by frame. During playback, you can use the jogwheel to increase or decrease the playback speed by up to 512x forward or backward.

The cliplist lists all clips contained on the recording medium:

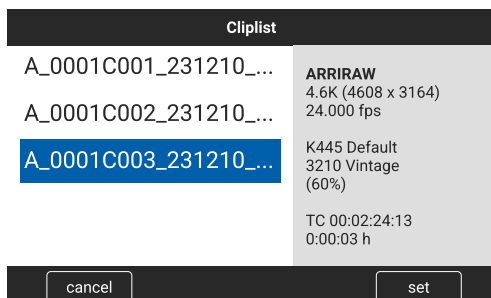

- ▶ Start Playback and select CLIPLIST
- ▶ Rotate the jogwheel to select a clip:

The first frame of the selected clip is displayed on all monitoring outputs for preview. The clip's properties are displayed in the info panel on the right: Codec, Recording Resolution, Record FPS, Texture, Look and Look Intensity, start TC and clip duration.

Look and Look Intensity are displayed in gray if the look the clip was recorded with does not correspond to the currently set look.
- ▶ Press the jogwheel or the *SET* button to play the clip, press *CANCEL* to return to the playback screen.

Note: Clips may be grayed out if they can not be played back because their recording resolution is not compatible with the currently set recording resolution.

The Play End Mode defines the behavior when playback reaches the end of a clip.

- ▶ Select *PLAY > Options*.

Following options are available:

<i>Pause on end</i>	Playback pauses at the end of the clip.
<i>Pause on start</i>	Playback pauses at the beginning of the clip.
<i>Loop</i>	Playback continues from the beginning of the same clip again.
<i>Play next clip</i>	Playback continues with the next clip in the cliplist.
<i>Exit playback</i>	Camera exits playback.

Playback Control via Side Display

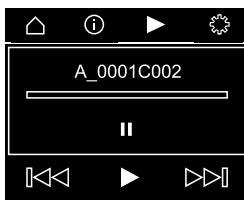

- ▶ Navigate to the playback page and press the clickwheel to enter playback.
- ▶ Toggle between play and pause by briefly pressing the clickwheel.
- ▶ While playing back, rotate the clickwheel to increase or decrease the playback speed by up to 512x forward or backward.
- ▶ While playback is paused, rotate the clickwheel to switch between the controls (skip back, play/pause, skip forward, navigation bar).
To exit playback, turn the clickwheel clockwise until the navigation bar is highlighted. Then press the clickwheel to exit playback mode.



User Button *Playback* supports to start and exit playback.

User Button *Check Last Clip* plays the last five seconds of the last recorded clip.

ATTENTION

Playback does not apply the Look file that is stored in the clip metadata. Instead, the currently set Look file is used during playback.

14 Monitoring

14.1 Surround View

Surround View displays additional pixels outside the captured image area (1), allowing the operator to see outside the captured image and keep unwanted objects, such as microphone booms, out of the shot. The Surround View area (2) is separated from the captured image area by the Surround Mask (here: 75% Mask). To view only the captured image, Surround View can be switched off.

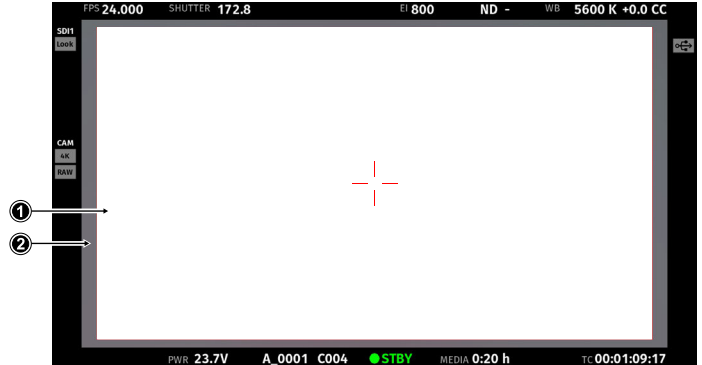

- ▶ Select *MENU > Monitoring > VF > Surround View* to configure Surround View for the VF outputs (EVF and Monitor).
- ▶ Select *MENU > Monitoring > SDI > SDI 1 Processing > Surround View* to configure Surround View for the SDI 1 output.
- ▶ Select *MENU > Monitoring > SDI > SDI 2 Processing > Surround View* to configure Surround View for the SDI 2 output.

Following options are available:

On	The captured image area is displayed with Surround View.
Off	The captured image area is displayed without Surround View.
Off + Colored Line	The captured image area is displayed without Surround View, outlined by a colored line (same color as frame lines).



User Buttons *VF Surround View*, *SDI 1 Surround View* and *SDI 2 Surround View* support to quickly set the surround view of the respective output.

Info: Surround View is not available for sensor modes 4.6K 3:2 Open Gate and 4.6K 16:9 as there are no more extra photo sites on the sensor.

Surround Mask

The Surround Mask helps to visually separate the Surround View area from the captured image area.

- ▶ Select *MENU > Monitoring > VF > EVF Surround Mask* to configure Surround Mask for the EVF.
- ▶ Select *MENU > Monitoring > VF > Monitor Surround Mask* to configure Surround Mask for the Monitor.
- ▶ Select *MENU > Monitoring > SDI > SDI 1 Processing > Surround Mask* to configure Surround Mask for the SDI 1 output.
- ▶ Select *MENU > Monitoring > SDI > SDI 2 Processing > Surround Mask* to configure Surround Mask for the SDI 2 output.

Following options are available:

Black Line	Surround View area is separated from the captured image by a black line.
Colored Line	Surround View area is separated from the captured image by a colored line (same color as frame lines).

- 25% Mask** Surround View area is separated from the captured image by a mask with 25% opacity.
- 50% Mask** Surround View area is separated from the captured image by a mask with 50% opacity.
- 75% Mask** Surround View area is separated from the captured image by a mask with 75% opacity.
- 100% Mask** Surround View area is separated from the captured image by a mask with 100% opacity.

Info: *Monitor Surround Mask* does not support *25% Mask* and *75% Mask*.

Info: When setting the frame lines outside shading for a monitoring output, the Surround Mask of the corresponding output is automatically adjusted.

14.2 Magnification



When shooting with frame lines or aspect ratios that only use a cropped area of a sensor mode the actual image content defined by the frame line might not be displayed large enough. The magnification setting gives the user access to a variable scaling of the monitoring outputs and sets a persistent image magnification, so the area defined by the frame line can be displayed as large as desired. Magnification can be adjusted in steps of 1% from 100% to 200% for the VF and the SDI outputs, individually or globally.



Two screen grabs from an ALEXA 35 in sensor mode 4.6K 3:2 *Open Gate* with a custom 16:9 4K frame line (red rectangle) applied. The left screen shot shows the SDI 1 output without magnification applied. The right screen grab shows the SDI 1 output with magnification applied to enlarge the image (in this example set to 130%).

- ▶ Select *MENU > Monitoring > Master Magnification* to set the magnification level for the VF outputs and the SDI outputs simultaneously.
When individual outputs have been set to different magnification values, the Master Magnification menu entry shows “-”. Changing the Master Magnification will force the magnification of all outputs to the new value.
- ▶ Select *MENU > Monitoring > VF > Magnification* to set the magnification level for the EVF and the Monitor.
- ▶ Select *MENU > Monitoring > SDI > SDI 1 Processing > Magnification* to set the magnification level for the SDI 1 output.
- ▶ Select *MENU > Monitoring > SDI > SDI 2 Processing > Magnification* to set the magnification level for the SDI 2 output.

The magnification icon on the left side of the Status Info indicates where the recorded area exceeds the displayed image:

-  Indication that the recorded image content horizontally (left and right) extends beyond what is visible on the output.
-  Indication that the recorded image content vertically (above and below) extends beyond what is visible on the output.
-  Indication that the recorded image content horizontally and vertically extends beyond what is visible on the output.

Info:

Magnification can only be applied on the SDI output(s) with *SDI Image* set to *Processed*.

Magnification is not available when using 2K or HD Recording Resolutions.

Magnification is reset to 100% when Sensor Mode or is changed.

Magnification is not available when the SDI output(s) are configured for UHD output (6G and 12G formats).

14.3 Frame Lines

To aid in framing, the camera offers to display frame lines overlaid over the live image. Frame lines can be considered electronic versions of ground glass markings in film cameras. You can configure which frame line the camera should show and how it should be displayed (color and opacity). You can also configure up to two user rectangles which allow you to mark a rectangular area on the image, e.g. for marking an area that you need to keep clear during shooting for later VFX insertion. Custom frame lines can be created using the online [Frame Line & Lens Illumination Tool](#). A standard set of frame lines for different aspect ratios is provided in the camera, the availability depends on the selected sensor mode.

Setting the Frame Line

- ▶ Select *MENU > Monitoring > Frame Lines > Frame Line*.
- ▶ Select a frame line from the list or [add](#) a custom frame line from an inserted USB medium or the defaults list.

Info: Frame lines can be only loaded if their aspect ratio matches the aspect ratio of the set sensor mode.

Setting the Center Mark

As already common for ground glasses for film cameras, the camera offers to display a center mark on each monitoring output.

- ▶ Select *MENU > Monitoring > VF > EVF Overlays > Center Mark* to configure the center mark for the EVF.
- ▶ Select *MENU > Monitoring > VF > Monitor Overlays > Center Mark* to configure the center mark for the Monitor.
- ▶ Select *MENU > Monitoring > SDI > SDI 1 Processing > Overlays* to configure the center mark for the SDI 1 output.
- ▶ Select *MENU > Monitoring > SDI > SDI 2 Processing > Overlays* to configure the center mark for the SDI 2 output.

Following options are available:

Off	Center mark is switched off.
Dot	Center mark is displayed as a dot.
Dot Small	Center mark is displayed as a small dot.
Cross	Center mark is displayed as a cross.
Cross Small	Center mark is displayed as a small cross.

Application of Frame Lines and Center Mark on Monitoring Outputs

For each monitoring output the camera offers to enable/disable display of frame lines and center mark.

- ▶ Select *MENU > Monitoring > VF > EVF Overlays > Frame Lines* to toggle display of frame lines and center mark on the EVF.
- ▶ Select *MENU > Monitoring > VF > Monitor Overlays > Frame Lines* to toggle display of frame lines and center mark on the Monitor.

- ▶ Select *MENU > Monitoring > SDI > SDI 1 Processing > Overlays > Frame Lines* to toggle display of frame lines and center mark on the SDI 1 output.
- ▶ Select *MENU > Monitoring > SDI > SDI 2 Processing > Overlays > Frame Lines* to toggle display of frame lines and center mark on the SDI 2 output.



User Buttons *VF Frame Lines*, *SDI 1 Frame Lines*, *SDI 2 Frame Lines* support to quickly enable/disable display of frame lines for the corresponding output.

Frame Line Display

When creating custom frame lines using the ARRI Frame Line & Lens Illumination Tool, you have the possibility to place up to three different frame lines (A, B, C) in one frame line file. However, the camera does not always have to display all three frame lines at the same time, but offers the possibility to configure which frame line(s) are displayed. This allows you to quickly switch between or combine these frame lines without having to load a new frame line file each time.

- ▶ Select *MENU > Monitoring > Frame Lines > Frame Line Display*

Following options are available:

Frame Line A	Toggle to enable/disable display of frame line A of the set frame line file.
Frame Line B	Toggle to enable/disable display of frame line B of the set frame line file.
Frame Line C	Toggle to enable/disable display of frame line C of the set frame line file.

Frame Line Color

The Frame Line Color setting defines the color of the frame line(s), the Center Mark, the User Rectangle(s) and the Surround Mask (if Surround Mask is set to *Colored Line*).

- ▶ Select *MENU > Monitoring > Frame Lines > Frame Line Color*.

Following options are available:

Red **Green** **Blue** **Cyan** **Magenta** **Yellow** **Black** **White**

Frame Line Opacity

The Frame Line Opacity setting defines the opacity of the frame line(s), the center mark, the user rectangle(s) and the surround mask (if surround mask is set to *Colored Line*).

- ▶ Select *MENU > Monitoring > Frame Lines > Frame Line Opacity*
- ▶ Set the frame line opacity in a range from **1** (the lowest opacity) to **4** (the highest opacity).

Outside Shading

The Outside Shading setting applies shading to the area between the frame line(s) and the remaining captured image area and can be set independently for each image output. When changing the Outside Shading of an output, the output's Surround Mask is adapted accordingly.

- ▶ Select *MENU > Monitoring > Frame Lines > Outside Shading*.

Following options are available:

EVF Outside Shading	Set the outside shading for the EVF (Off, 25%, 50%, 75%, 100%).
Monitor Outside Shading	Set the outside shading for the Monitor (Off, 50%, 100%).
SDI 1 Outside Shading	Set the outside shading for the SDI 1 output (Off, 25%, 50%, 75%, 100%).
SDI 2 Outside Shading	Set the outside shading for the SDI 2 output (Off, 25%, 50%, 75%, 100%).

User Rectangles

To further aid in framing, the camera supports to display two custom user rectangle overlays. You can configure *width*, *height* and *offset* (position from left and top of image area).

- ▶ Select *MENU > Monitoring > Frame Lines > User Rectangles > User Rectangles*.

Following options are available:

Off	User Rectangles are not displayed.
Rectangle 1	Only user rectangle 1 is displayed.
Rectangle 2	Only user rectangle 2 is displayed.
Rectangle 1 + 2	User rectangles 1 + 2 are displayed.

- ▶ Select *MENU > Monitoring > Frame Lines > User Rectangles > User Rectangle 1* or *User Rectangle 2*.

Following options are available:

Width	Adjusts the user rectangle width in the range of 0-999.
Height	Adjusts the user rectangle height in the range of 0-999.
Offset Left	Adjusts the horizontal user rectangle offset in the range of 0-1000.
Offset Top	Adjusts the vertical user rectangle offset in the range of 0-1000.
Reset All	Resets all values.

14.4 False Color

False Color is an exposure tool to check for correct exposure. When active, the image is turned into a gray scale image with important luminance ranges shown in signal colors. Activating False Color temporarily switches the corresponding output to LogC4 and replaces luminances with the following colors:

Red	1/3 stop below clipping
Yellow	2/3 stops below clipping
Pink	1 stop above 18% middle gray
Green	18% middle gray
Blue	Edge of shadow detail
Purple	Noise floor

When a gray card is used (or another object in the scene has a similar reflectance level), the exposure can be set such that the card is in the green zone.

- ▶ To activate False Color on both EVF and Monitor, press the EXP button (1) on the MVF-2. Press the EXP button again to deactivate False Color.

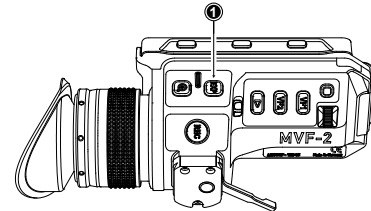

 User Buttons *VF False Color*, *SDI 1 False Color* and *SDI 2 False Color* support to quickly enable/disable False Color on the corresponding outputs.

Additionally, False Color can be activated in the camera menu:

- ▶ Select *MENU > Monitoring > SDI > SDI 1 Processing > False Color* to activate False Color on the SDI 1 output.
- ▶ Select *MENU > Monitoring > SDI > SDI 2 Processing > False Color* to activate False Color on the SDI 2 output.

 Active False Color is indicated by the exposure tool icon in the Status Info of the respective output.

14.5 Peaking

Peaking highlights in-focus areas for better focus control.

Info: Peaking is not supported on SDI 2.

Peaking Mode

- ▶ Select *MENU > Monitoring > Peaking > VF Peaking Mode* to set the preferred peaking mode for EVF and Monitor.
- ▶ Select *MENU > Monitoring > Peaking > SDI 1 Peaking Mode* to set the preferred peaking mode for SDI 1.

Following options are available:

Color	Color peaking overlays in-focus areas with a selected color.
Aperture	Aperture peaking enhances object edges only.

Peaking Level

- ▶ Select *MENU > Monitoring > Peaking > VF Peaking Level* to set the peaking strength for EVF and Monitor.
- ▶ Select *MENU > Monitoring > Peaking > SDI 1 Peaking Level* to set the peaking strength for SDI 1.
- ▶ Set the peaking level from **1** (the minimum strength) to **20** (the maximum strength).

Offset Shift

The peaking offset shift sets the threshold for Color Peaking to become active, relative to the peaking level.

- ▶ Select *MENU > Monitoring > Peaking > VF Peaking Offset Shift* to set the peaking offset for EVF and Monitor.
- ▶ Select *MENU > Monitoring > Peaking > SDI 1 Peaking Offset Shift* to set the peaking offset for SDI 1.
- ▶ Set the offset shift from **-5** (the minimum) to **+5** (the maximum).

Color

Select the color for Color Peaking.

- ▶ Select *MENU > Monitoring > Peaking > VF Peaking Color* to set the color for color peaking on EVF and Monitor.
- ▶ Select *MENU > Monitoring > Peaking > SDI 1 Peaking Color* to set the color for color peaking on SDI 1.

Following options are available:

Red	Green	Blue	Cyan	Magenta	Yellow	White
------------	--------------	-------------	-------------	----------------	---------------	--------------

Activation of Peaking



User Buttons *VF Peaking* and *SDI 1 Peaking* support to quickly enable/disable peaking on the respective output.



Active peaking is indicated through the peaking icon displayed in the Status Info of the respective output.

14.6 Zoom

The camera supports to zoom into the image e.g. to better judge focus. Zoom is essentially a shortcut to quickly achieve maximum Magnification. The camera offers six zoom positions: center, top left, top center, top right, bottom right and bottom left. While Zoom is activated, the zoom position can be changed by using the jogwheel, the soft buttons on the MVF-2 (if the Monitor is flipped out and set to display the live image) or through user buttons. Active Zoom is indicated by an orange frame around the image. Frame lines and anamorphic desqueeze are temporarily deactivated while Zoom is active.

- ▶ Press the **ZOOM** button to activate/deactivate Zoom on EVF and Monitor.
- ▶ To change the Zoom position, rotate either the jogwheel or the user wheel.

Info: Changing the zoom position using the jogwheel or user wheel is not supported when the Monitor is set to display the HOME screen or the camera menu.

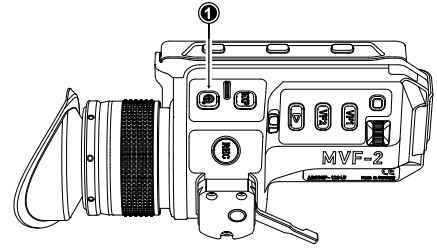

User Button *VF Zoom* supports to quickly enable/disable zoom for EVF and Monitor.

Zoom on SDI



Zoom on the SDI outputs can only be activated through a user button. The camera offers three SDI Zoom related user button functions:

- ▶ Select *MENU > User Buttons* and assign *SDI 1 Zoom* or *SDI 2 Zoom* to the desired button. The user button activates/deactivates Zoom on the respective SDI output.
- ▶ Select *MENU > User Buttons* and assign *SDI 1 Zoom Position* or *SDI 2 Zoom Position* to the desired button. While Zoom is activated, the user button changes the Zoom position on the respective output.
- ▶ Select *MENU > User Buttons* and assign *SDI 1 Zoom (Smart)* or *SDI 2 Zoom (Smart)* to the desired button. The user button activates Zoom on the first button press, further button presses change the zoom position and a button long press deactivates Zoom.

Info:

Zoom is not available when using 2K or HD recording resolutions.

SDI Zoom is not available when the SDI output(s) are configured for UHD output (6G and 12G formats). Zoom always refers to the entire image area of the set sensor mode and does not take into account any set Magnification.

Zoom temporarily deactivates anamorphic desqueeze.

14.7 SDI Settings

SDI Image

The setting for the SDI image determines whether the SDI image is output as a clean feed or including status information and status overlays.

- ▶ Select *MENU > Monitoring > SDI > SDI 1 Image*

Following options are available:

Clean	Image is output as a clean feed. Neither status overlays, frame lines nor surround view are displayed. Magnification is not supported.
Processed	Image may include status information and overlays.

- ▶ Select *MENU > Monitoring > SDI > SDI 2 Image*.

Following options are available:

Clean	Image is output as a clean feed. Neither status overlays, frame lines nor surround view are displayed. Magnification is not supported.
Processed	Image may include status information and overlays.

Clone SDI 1 The SDI 2 output is automatically configured by the SDI 1 settings. The following SDI 1 settings are transferred to the SDI 2 output:

Format	Frame Rate	Image (clean/processed)
Surround View	Surround Mask	Magnification
Overlays	Frame Lines (on/off)	Center Mark
Status Info	Status Components	Overlay Brightness
Hide Messages	Outside Shading	Processing (LogC4 / WVO LogC4 / Look)
Color Space	3G Level	

SDI Format

- ▶ Select *MENU > Monitoring > SDI > SDI 1 Format* to set the format of the SDI 1 output.
- ▶ Select *MENU > Monitoring > SDI > SDI 2 Format* to set the format of the SDI 2 output.

Following options are available:

422 1.5G HD	Images are output according to SMPTE 292M. Available frame rates are 23.976p/psf, 24p/psf, 25p/psf, 29.97p/psf and 30p/psf p (progressive) transmits images line by line starting at the top left pixel. psf (progressive segmented frame) splits progressive images into fields (odd lines and even lines) and transmits these (all odd before all even) line by line.
422 3G HD	Images are output according to SMPTE ST 424:2012 Available frame rates are 48p, 50p, 59.94p and 60p
444 3G HD	Images are output according to SMPTE ST 424:2012 Available frame rates are 23.976p, 24p, 25p, 29.97p and 30p
422 6G UHD	Images are output according to SMPTE ST 2081-10:2015 Available frame rates are 23.976p, 24p, 25p, 29.97p and 30p

422 12G UHD Images are output according to SMPTE ST 2048-1
Available frame rates are 48p, 50p, 59.94p and 60p

444 12G UHD Images are output according to SMPTE 2082-10:2015
Available frame rates are 23.976p, 24p, 25p, 29.97p and 30p

Info: 48p may not be supported by some SDI devices, as this is not a defined frame rate according to the SMPTE standard.

Info: 6G / 12G formats are not available when the recording resolution is set to 2K or HD.

SDI Frame Rate

The SDI frame rate determines the number of images that are output per second on the SDI output(s). It should be set equal to the sensor frame rate. If the frame rate is lower than the sensor frame rate, frame drops will occur. If it is higher, duplicate images will be output. The available SDI frame rates depend on the selected SDI format.

- ▶ Select *MENU > Monitoring > SDI > SDI 1 Frame Rate* to set the frame rate of the SDI 1 output.
- ▶ Select *MENU > Monitoring > SDI > SDI 2 Frame Rate* to set the frame rate of the SDI 2 output.

SDI 3G Level

For the 3G SDI formats, you can choose whether to use 3G level A or B. Refer to the instructions of your connected devices to decide which 3G level to use.

- ▶ Select *MENU > Monitoring > SDI > SDI 1 3G Level* to set the 3G level for the SDI 1 output.
- ▶ Select *MENU > Monitoring > SDI > SDI 2 3G Level* to set the 3G level for the SDI 2 output.

Hide Messages

User messages displayed as overlays on the monitoring outputs are primarily relevant for the camera team and do not necessarily need to be displayed on the SDI output that other crew members are viewing. The camera offers the possibility to suppress all user messages on a selected SDI output.

- ▶ Select *MENU > Monitoring > SDI > SDI 1 Processing > Hide Messages* to hide user messages on the SDI 1 output.
- ▶ Select *MENU > Monitoring > SDI > SDI 2 Processing > Hide Messages* to hide user messages on the SDI 2 output.

14.8 EVF and Flip-out Monitor Settings

EVF Brightness

The brightness of the EVF is adjustable with values 120, 200 and 300 (Nits).

- ▶ Select *MENU > Monitoring > VF > Settings > EVF Brightness* to set the brightness of the viewfinder OLED between **120**, **200** or **300**.

Info: When *VF Processing* is configured for *Look (EVF: HDR, Mon: SDR)*, the EVF brightness is fixed to 500 nits and can't be changed.

EVF Power

- ▶ Select *MENU > Monitoring > VF > Settings > EVF Power*

Following Options are available:

Auto	EVF display is activated and deactivated automatically, depending on the MVF-2 proximity sensor state. This is the default setting.
Off	Deactivates the EVF display permanently so that it remains switched off even when the proximity sensor is covered e.g. by a rain cover.
On	Use this setting to override the MVF-2 proximity sensor and to constantly enable the EVF display. This setting should be regarded as an emergency setting to be used, for example, when the proximity sensor is faulty and no longer activates the EVF display anymore.

ADVICE

Please be aware that when enabled, and used for prolonged periods, this configuration may cause irreversible burn-ins on the EVF OLED. With the setting enabled, the camera will issue a corresponding warning after each boot-up and sensor mode switch.

EVF Eyepiece Heating

The MVF-2 viewfinder is equipped with a built-in eyepiece heater to prevent fogging of the eyepiece when shooting in cold environments. The eyepiece heater becomes active when the eyepiece has a temperature of 15° C / 59° F or below. In really cold environments please use the Heated Eyecup HE-7.

- ▶ Select *MENU > Monitoring > VF > Settings > EVF Eyepiece Heating* to enable/disable EVF eyepiece heating.



Active eyepiece heating is indicated through an icon displayed on the HOME screen. The icon is displayed gray if eyepiece heating is inactive.

EVF Image Rotation 180°

When mounting the MVF-2 on the right side of the camera, the EVF image can be rotated by 180° for correct orientation.

- ▶ Select *MENU > Monitoring > VF > Settings > EVF Image Rotation 180°* to enable/disable the rotation.

Monitor Brightness

- ▶ Select *MENU > Monitoring > VF > Settings > Monitor Brightness*

to adjust the brightness of the MVF-2 flip-out monitor from **1** (the minimum brightness) to **10** (the maximum brightness).

Monitor Flip Mode

- ▶ Select *MENU > Monitoring > VF > Settings > Monitor Flip Mode*

Following options are available:

Auto	Flips the Monitor image automatically depending on the monitor's orientation. This is the default setting.
Normal	Ignores the Monitor's orientation sensor and displays the Monitor image in normal orientation.
Flipped	Ignores the Monitor's orientation sensor and displays the monitor image in flipped orientation (upside down).



User Button *Flip Monitor* supports to quickly set the Monitor flip mode.

14.9 Return In

The SDI 2 output of the camera can be switched to a Return In input to feed 1.5G or 3G SDI signals into the camera and display them on the EVF and flip-out monitor and/or the SDI 1 output.

- ▶ Select *MENU > Monitoring > Return In > Use SDI 2 as Return In* to configure the SDI 2 output to function as an image input.
- ▶ Select *MENU > Monitoring > Return In > Show Return In on VF* to display the return in image on the EVF and the Monitor.
- ▶ Select *MENU > Monitoring > Return In > Show Return In on SDI 1* to display the return in image on the SDI 1 output.

Info: SDI 2 related settings can't be adjusted while SDI 2 is configured to function as return in.

Activation of Return In



Return In can only be switched on and off using a user button assigned with *Return In*.

- ▶ Select *MENU > User Buttons* and assign *Return In* to the desired button.
- ▶ Press the user button to activate Return In.

14.10 SDI Color Bars

The camera supports to output SMPTE color bars on the SDI outputs. The color bars are a 10-bit signal according to SMPTE RP 219-2002. Color bars will always bypass the ALF4 look file. These are SDR color bars, set the SDI color space to either Rec 709 (SDR) or Rec 2020 (SDR) for correct display.

- ▶ Select *MENU > Monitoring > SDI Color Bars* to switch color bars on or off.

Info: Color bars are switched off when recording is started.



User Button *SDI Color Bars* supports to quickly enable/disable color bars on the SDI outputs.

15 User Buttons

The camera is equipped with nine assignable user buttons, 1-6 on the left and 7-9 on the camera right side. The MVF-2 is equipped with two additional user buttons, VF 1 and VF 2. Each button can be assigned a variety of functions.

Once a button is assigned a function, press the button to trigger the function. The blue LED on the button reflects the functional status.

In addition to the user buttons of the camera and the MVF-2, the camera supports to assign functions to the user buttons of electronic accessories such as the hand units HI-5 and WCU-4, ARRI Master Grips, Operator Control Unit OCU-1 and the GPIO box.

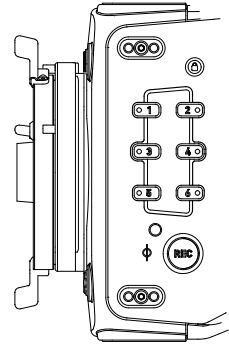

Some user button functions support smart behavior. For these, a short press triggers the function, while a long press activates the function only temporarily, as long as the user button is pressed.

► Select *MENU > User Buttons >*

- Camera User Buttons* to assign the camera user buttons (1-9).
- MVF-2 User Buttons* to assign the MVF-2 user buttons (VF 1 & VF 2).
- Monitor User Buttons* to assign the user buttons on the CCM-1 (1-4).
- Hand Unit User Buttons* to assign the user buttons of HI-5 and WCU-4 (1-6).
- LBUS Device User Buttons* to assign the user buttons of ECS devices like the ARRI Master Grips and the OCU-1 (1-12).
- GPIO User Buttons* to assign the user buttons of the GPIO Box (1-14).
- Lens RET* to assign the RET button of an ENG lens servo.

Following user button functions are available:

- Off** Disables the user button.
- VF, SDI 1, SDI 2 Status Info** Switching Status Info between *Safe*, *Off* and *Overlay* on the chosen output.
- VF, SDI 1, SDI 2 Check LogC4** Switching the processing of the chosen output between the currently set value and LogC4. Supports smart behavior.
- VF Check HDR** Switching the EVF processing between the currently set value and HDR. Supports smart behavior.
- VF, SDI 1, SDI 2 False Color** Switching the False Color exposure tool on and off on the chosen output. Supports smart behavior.
- VF, SDI 1, SDI 2 Frame Lines** Switching the frame lines on and off on the chosen output. Supports smart behavior.
- VF, SDI 1 Peaking** Switching Peaking on and off on the chosen output. Supports smart behavior.
- VF Processing** Switching VF Processing between *LogC4*, *Look (SDR)* and *Look (EVF: HDR, Mon: SDR)*.
- VF, SDI 1, SDI 2 Surround View** Switching Surround View between *On*, *Off* and *Off + Colored Line* on the chosen output.

<i>VF , SDI 1, SDI 2 Zoom</i>	Switching Zoom on and off on the chosen output.
<i>VF , SDI 1, SDI 2 Zoom Position</i>	Switching the zoom position.
<i>VF , SDI 1, SDI 2 Zoom</i>	Press to activate Zoom. Further button presses switch the Zoom position. A button long press deactivates Zoom.
<i>SDI Color Bars</i>	Turns SDI color bars on or off.
<i>EI Increase</i>	Increases the exposure index to the next value in the list.
<i>EI Decrease</i>	Decreases the exposure index to the next lower value in the list.
<i>FPS Increase</i>	Sets the sensor frame rate to the next higher value in the list.
<i>FPS Decrease</i>	Sets the sensor frame rate to the next lower value in the list.
<i>FPS Preset</i>	Sets the sensor frame rate to a user defined value.
<i>ND Increase</i>	Sets the ND filter to the next higher value in the list.
<i>ND Decrease</i>	Sets the ND filter to the next lower value in the list.
<i>Shutter Increase</i>	Sets the shutter to the next higher value in the list.
<i>Shutter Decrease</i>	Sets the shutter to the next lower value in the list.
<i>WB Increase</i>	Sets the white balance to the next higher value in the list.
<i>WB Decrease</i>	Sets the white balance to the next lower value in the list.
<i>Audio Ch1 Increase</i>	Increases gain of audio channel 1 in 1dB steps.
<i>Audio Ch1 Decrease</i>	Decreases gain of audio channel 1 in 1dB steps.
<i>Audio Ch2 Increase</i>	Increases gain of audio channel 2 in 1dB steps.
<i>Audio Ch2 Decrease</i>	Decreases gain of audio channel 2 in 1dB steps. (requires channel control set either to <i>Manual</i> or <i>Manual (+L)</i>)
<i>Audio Mute int. Mic</i>	Mutes / unmutes the internal microphones.
<i>Audio Solo</i>	Mutes all audio recording channels except one. Toggles through Off, Ch1, Ch2, Ch3, Ch4, selecting the next channel with every button press. Channels that are not assigned to an audio input are skipped. When Audio Solo is active, the selected channel is marked in the audio bars displayed in the status info and the homescreen. Audio Solo only affects the headphones output (not the embedded audio in the SDI stream).
<i>Auto WB</i>	First press displays the auto white balance overlay, press the button again within one second to execute auto white balance.
<i>Check Last Clip</i>	Plays the last five seconds of the last recorded clip, then playback is exited.
<i>EF Close Iris</i>	Closes the iris of an EF lens (only available when EF Mount is attached).
<i>EF Open Iris</i>	Opens the iris of an EF lens (only available when EF Mount is attached). Short press closes/opens by 1/x stop (step size depending on lens), long press closes/opens by 1 stop.
<i>Flip Monitor</i>	Switching the flip-out monitor between normal and flipped mode. To return to automatic flip mode, press and hold button for two seconds.

Frame Grab	Grabs a LogC4 still frame in .JPG and .DPX format and saves it to the USB medium. Frame grabs are taken from the SDI image path (including SDI settings such as processing, active look and anamorphic desqueeze) but cropped to the active image area. Hence, the frame grab resolution depends on the SDI format and the applied SDI settings.
	 Active frame grab is indicated though the grab icon displayed on the HOME screen as well as the Status Info. The icon turns orange when the frame grab could not be saved.
Mirror Image	Switching Mirror Image between <i>Off</i> , <i>V</i> , <i>H</i> and <i>V+H</i> .
Playback	Press and hold to start playback, then press to toggle play/pause, press and hold again to exit playback.
Prerecording	Starting and stopping Prerecording.
Record Start/Stop	Starting and stopping recording.
Return In	Switching on and off the return in signal present at the SDI 2 connector. Supports smart behavior.
WiFi Power	Toggles WiFi power On and Off.

16 Synchronization

The camera's sensor and SDI outputs can be synchronized to either a genlock signal (a tri-level HD signal or an analog black burst signal) present at the BNC SYNC IN connector (1) or a timecode signal present at the 5-pin LEMO TC connector (2). The camera's sensor needs to run at equal or double the frame rate of the reference signal to establish synchronization.

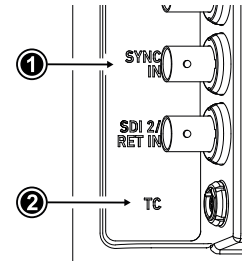

- ▶ Select *MENU > System > Sensor > Genlock Sync*.

Following options are available:

- Off** Synchronization is not enabled.
- Sync In** The camera will synchronize to a tri-level or black burst signal present at the SYNC IN connector.
- Timecode** The camera will synchronize to timecode present at the TC connector.

GEN Active synchronization is indicated by the Genlock icon on the HOME screen and in the Status Info. The icon turns orange when the camera cannot synchronize to the reference signal or when no signal is present. See *MENU > Alerts* for detailed information.

Info: Simultaneous use of the timecode mode *Jam-sync* and *Genlock Sync* is not supported.

Sync Shift

The Sync Shift setting can be used to apply an offset to the reference signal at the input. The minimum step size is 52 ns and the maximum correction is +/- 20 ms, depending on the sensor frame rate.

- ▶ Select *MENU > System > Sensor > Sync Shift* to adjust the sync shift.

17 Sensor Settings

17.1 Mirroring the Sensor Image

You can mirror the sensor image in horizontal and vertical directions.

Horizontal mirroring is applied on all monitoring paths and internally recorded material. Vertical mirroring is only applied to the monitoring outputs; internally recorded material is not vertically flipped, but the information is written into metadata.

- ▶ Select *MENU > Image > Mirror Image*.

Following options are available:

Off	Mirroring is inactive.
V	The sensor image is vertically mirrored.
H	The sensor image is horizontally mirrored.
V+H	The sensor image is vertically and horizontally mirrored (rotated by 180°).



User Button *Mirror Image* supports to quickly switch Mirror Image.

17.2 User Pixel Masking

All sensors exhibit a certain number of defect pixels, and ARRI cameras have three mechanisms to catch and correct them: one is a static pixel correction based on a pixel mask created during manufacturing. The second is a dynamic pixel correction that continuously evaluates each frame and masks defect pixels that are not caught by the static pixel mask. In very few cases, we have observed some pixels that are not corrected by either method; for those cases the third, User Pixel masking, is available. User pixel masks can be created using the ARRI Reference Tool (ART).

When shooting ARRIRAW, it is not necessary to load the User Pixel Mask into the camera. Instead, it can be applied to the ARRIRAW files in post production using the ARRI Reference Tool or any third party software that has implemented the User Pixel Mask feature through the ARRI Image SDK.

The User Pixel Mask will remain intact after a factory reset and after a camera software update. It can be manually removed or overwritten with a new one at any time.

- ▶ Select *MENU > System > Sensor > User Pixel Masking*.

<i>Install User Pixel Mask</i>	Select to install a User Pixel Mask from USB memory stick.
<i>Export User Pixel Mask</i>	Select to back up the currently installed User Pixel Mask onto USB memory stick.
<i>Delete User Pixel Mask</i>	Select to uninstall a User Pixel Mask.
<i>Grab Raw Image</i>	Stores an ARRIRAW frame grab on the USB memory stick.

User Pixel Mask Generation

- ▶ Insert a USB memory stick into camera.
- ▶ Select *MENU > System > Sensor > User Pixel Masking > Grab Raw Frame* to grab an ARRIRAW frame.

The ARRIRAW frame grab is stored on the USB memory stick in folder ARRI/ALEXA35/SENSOR. Alternatively, you can record a short ARRIRAW sequence and use that material for marking defect pixels.

- ▶ Import the ARRIRAW frame grab into the ARRI Reference Tool.

- ▶ Use the ARRI Reference Tool to mark defect pixels. The marked pixel coordinates are stored in an XML file called the User Pixel Mask. Please note that it is advisable to mark the least number of pixels necessary, as too many marked pixels can be counter productive.
Please refer to the ARRI Reference Tool user manual for further information.
- ▶ Save the User Pixel Mask to the USB memory stick in folder ARRI/ALEXA35/SENSOR.
- ▶ Insert the USB memory stick into the camera.
- ▶ Select *MENU > System > Sensor > User Pixel Masking > Install User Pixel Mask* to load the mask into the camera.
- ▶ After a restart of the camera, the marked pixels will be masked using information from surrounding pixels. This masking is applied to the images delivered from the sensor, before any other processing takes place, and therefore becomes active on all outputs.
- ▶ Carefully check the end result by visually inspecting the areas where you have marked pixels; if too many pixels are marked too close to each other, or if pixels are marked close to other pixels that are already marked in the static pixel mask, the result could be uncorrectable clusters, which are more visible than the original defect pixels.

As an added service, it is possible to send the User Pixel Mask to ARRI Service at service@arri.com for verification. We strongly recommend that you take advantage of this free service, as sometimes, clusters are difficult to spot depending on the background. Please note, however, that in the end, it is the responsibility of the person creating the User Pixel Mask to verify that no clusters are formed.

ADVICE

Please note, that the User Pixel masking feature is only a temporary solution to mask defect pixels. Defect pixels should be dealt with by sensor calibration at an ARRI service department.

A User Pixel Mask is a stopgap solution between when the defect is noticed, and when the camera is recalibrated, to verify the sensor is still functioning within ARRI specifications and to comprehensively assess and permanently and automatically compensate for defect pixels.

18 System Settings

18.1 Language Setting

- ▶ Select *MENU > System > Language* to set the system language between **English** and **Chinese** (simplified).

18.2 System Time and Date

- ▶ Select *MENU > System > System Time + Date* to set the system time and date.

18.3 Button and Display Settings

Display Style

- ▶ Select *MENU > System > Buttons + Display > Display Style* to set the display style between **Day** or **Night**.

Button Brightness

- ▶ Select *MENU > System > Buttons + Display > Button Brightness* or *Select Side Display > Settings > Button Brightness* to set the brightness of camera and MVF-2 buttons from **0** (off) to **4** (the highest brightness).

MVF-2 Touch

- ▶ Select *MENU > System > Buttons + Display > MVF-2 Touch* to enable / disable the touchscreen functionality on the MVF-2.



The touch lock icon on the HOME screen indicates that the touchscreen functionality is switched off.

18.4 Fan Settings

Select to set the fan mode to *Low Noise* for locations with ambient temperatures up to 30°C (86°F). For locations with ambient temperatures higher than 30°C (86°F), set to *Rec Low*.

- ▶ Select *MENU > System > Fan Mode*.

Following options are available:

Rec Low

Increases fan speed during standby to cool the camera. Minimizes fan speed/noise during recording. Ideal in an environment warmer than 30 °C (86 °F).

Low Noise

Minimizes fan noise during standby and recording.

Info: With data rates above 100 MB/s (due to fps/codec setting), the fan speed automatically increases to prevent the camera from overheating.

18.5 Reset of Electronic Horizon

- ▶ Select *MENU > System > Reset Electronic Horizon*.
- ▶ Place the camera on a level surface and press **RESET**.

Info: A message is displayed if either the roll, the tilt or both values exceed the calibration range and resetting is not possible.

18.6 Update

ADVICE

Use a fully charged battery or a mains power supply to avoid power loss during updates.
Do not switch off the camera or unplug power during update processes.
Do not disconnect or remove components that are being updated.

18.6.1 Update of Camera Software

The camera software is updated using a USB-C memory stick. The Software Update Package (SUP) will update the camera along with the MVF-2 and the lens mount – provided they are connected to the camera. Before updating the camera, create the required folder structure on a USB-C memory stick. For more information, see "[User Storage](#)".

Software Update Package Download

- ▶ Download the software update package (SUP) from the [Software and Firmware Updates for Cameras](#) section of our website.
- ▶ Double-click on the downloaded file (*.zip) to unpack it:

Update file (*.swu)	Update key (*.lic)	Release notes
---------------------	--------------------	---------------

- ▶ Carefully read the release notes.
- ▶ Copy the update file (*.swu) to folder ARRI/ALEXA35/SUP on the memory stick.
- ▶ Copy the update key (*.lic) to folder ARRI/ALEXA35/LICENSES on the memory stick.

Camera Update

- ▶ Connect the USB-C memory stick to the camera.
- ▶ Select *MENU > Setup > Factory Reset* to perform a factory reset.
- ▶ Select *MENU > System > Update > Update Camera*.
- ▶ Select the required update file and press *CONFIRM* to start the update.
Wait for the update process to finish. The update procedure takes about ten minutes.
After a successful update and reboot, the camera displays a success message.

18.6.2 Update of Camera Components

The camera supports to update the MVF-2 viewfinder and the lens mount. Updating the MVF-2 and the lens mount does not require a dedicated update file. The camera will issue a message if the software version of MVF-2 and/or the lens mount does not match the version required by the currently installed camera software.

- ▶ Select *MENU > System > Update*.
The *Update MVF-2* and *Update Lens Mount* entries show the software version installed on the component and the software version required by the currently installed camera software.
- ▶ Select *Update MVF-2* to update the MVF-2 or
Select *Update Lens Mount* to update the lens mount.
- ▶ Press *CONFIRM* to start the update.

18.6.3 Update of LBUS Devices

LBUS devices such as cforce mini motors, cforce Plus motors, ARRI Master Grips, ARRI Operator Control Unit OCU-1 and ARRI LCUBE can be updated by the camera. The update requires an update file which can be downloaded from the ARRI website.

- ▶ Download the update file for the desired device from the [Software Updates ECS](#) section of our website.
- ▶ Copy the update file onto a USB-C memory stick in folder ARRI/ECS/. Connect the memory stick to the camera.
- ▶ Connect the LBUS device to the LBUS connector of the camera or the lens mount.
- ▶ Select *MENU > System > Update > Update LBUS Devices*.

A list with the connected LBUS devices is displayed, showing the software version currently installed on the device and the software version stored on the memory stick.

- ▶ Select the LBUS device you want to update and press *UPDATE*.
- ▶ Press *CONFIRM* to start the update. Cancel with *BACK*.

18.6.4 Update of Codex Compact Drive

The camera supports to update Codex Compact Drives. Updating does not require a dedicated update file. The camera will issue a message if the firmware version of the inserted drive needs to be updated.

ADVICE	
	All data contained on the drive will be deleted by the update. Make sure that you have backed up all data before starting the update.

- ▶ Select *MENU > System > Update*.
The *Update Media* entry shows the software version installed on the inserted Compact Drive, and the software version required by the currently installed camera software.
- ▶ Select *Update Media* to update the inserted Compact Drive.
- ▶ Press *CONFIRM* to start the update.

Info: After the update, the camera must be rebooted to be able to record and resume normal operation. However, if additional drives need to be updated, no reboot is required, you can proceed directly with the update of the next drive.

18.6.5 Update of PDM-1

The camera supports to update the Power Distribution Module PDM-1. Updating does not require a dedicated update file. The camera will issue a message if the firmware version of the PDM-1 needs to be updated.

- ▶ Select *MENU > System > Update*.
The *Update PDM-1* entry shows the software version installed on the PDM-1, and the software version required by the currently installed camera software.
- ▶ Select *Update PDM-1* to update the PDM-1.
- ▶ Press *CONFIRM* to start the update.

19 User Setups

A user setup is a profile of the current settings on the camera that can be saved on camera and/or to a USB memory stick. User setups can be given custom names, saved to the USB memory stick and loaded onto multiple cameras. Rather than resetting the camera to its factory default settings, a user setup can be used to reset the camera to a user's default settings.

User setups can be used to ensure that cameras on multi camera shoots have matching settings, or to transfer a show's setup onto daily cameras, to ensure they carry the same shooting specifications.

Saving a User Setup

You can save the current setup configuration in the camera or to the USB medium.

- ▶ Select *MENU > Setup > User Setups Installed > Save* to save the setup in the camera.
Select *MENU > Setup > User Setups on USB > Save* to save the setup on the USB medium.
- ▶ Use the onscreen keyboard to enter a name for the user setup and press *SAVE*.
A screen is displayed to select the setup parameter blocks with following options:

General	Groups the general camera configuration and basic project settings.
Format	Saves set codec, sensor mode and recording resolution.
Scene	Saves scene related parameters such as Shutter and Exposure Index.
Lens	Saves active lens table setting to quickly change between lens configurations.
User	Stores all parameters for camera personalization (overlays etc.)

- ▶ Select one or more options and press *CONFIRM*.

Loading a User Setup

- ▶ Select *MENU > Setup > User Setups Installed* to load a setup from the camera.
Select *MENU > Setup > User Setups on USB* to load a setup from the USB medium.
- ▶ Select a user setup from the list and press *LOAD*.
A pop up window with the parameter blocks of this user setup is displayed.
- ▶ Press *CONFIRM*.
The camera loads the selected user setup and shows a result message. The pop up highlights the parameters that you should check in case certain parameters could not be loaded.

Factory Reset

You can reset the camera to the ARRI factory default values.

- ▶ Select *MENU > Setup > Factory Reset*.
- ▶ Press *RESET*.
The camera settings are reset to factory defaults.

Info: A factory reset does not delete user setups stored/installed on camera.

19.1 User Setup Parameter Blocks

The camera allows you to store a full camera configuration by selecting all parameter blocks, or only parts of the configuration by de-/selecting the desired blocks. The parameter blocks have been chosen to allow for maximum flexibility while keeping coherent sets of parameters and minimizing the amount of potential conflicts by loading partial setups.

General

Groups the general camera configuration and basic project settings.

Project Rate	Installed Look Files	Sensor FPS Presets	SDI 1&2 Format
Audio (All Settings)	Installed Texture Files	Shutter Presets	SDI 1&2 Frame Rate
Timecode (All Settings)	Installed Frame Line Files	WB Presets	SDI 1&2 Image
Metadata (All Settings)	CAP Settings	ECS Radio Power	SDI 1&2 3G Level
Genlock Sync	Mirror Image	ECS Radio Channel	Streaming Metadata (all settings)
Sync Shift	Fan Mode	Prerec max. Duration	

Format

Allows for easy switching between recording formats.

Recording Codec	Sensor Mode	Recording Resolution	Active Frame Line
-----------------	-------------	----------------------	-------------------

Scene

Allows you to change quickly between different shooting situations.

Sensor FPS	Exposure Index	ND Filter	Active Texture
Shutter	White Balance	Active Look	EF Iris Value

Lens

Allows you to change quickly between different lens setups.

Lens Squeeze Factor	Lens Tables Installed	Lens motors direction	Lens motors teeth count
Active Lens Table	Lens Table Favorites	Lens motors torque	Focus Unit

User

Stores all parameters for camera personalization.

SDI 1&2 Processing (all settings)	User Buttons (all settings)	BAT Warning	EVF Overlays (all settings)
VF Surround View & Mask	Peaking (all settings)	PWR Warning	Monitor Overlays (all settings)
	Play End mode	Display Style	VF Settings (all, except <i>EVF Power</i>)
	Rec Beeper / Tally	Button Brightness	

Info: Network settings are not stored in the user setup.

20 Network

A network connection can be used to remotely control the camera. The camera's Web Remote, the Camera Companion App or other applications communicating with the camera via the Camera Access Protocol (CAP) can be connected to the camera via Ethernet or WiFi.

The Ethernet connector (1) is located on the right side of the camera. Use the ALEXA ETH/RJ45 (3.0m/9.8ft) KC 153-S (K2.72021.0) cable to connect the camera to a computer or network.

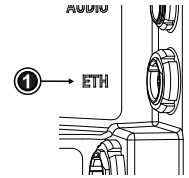

The camera is equipped with a 2.4 GHz WiFi module and two WiFi antennas (2, 3), both located on the back of the camera.

The WiFi module of the camera can be configured to act as an access point or in infrastructure (client) mode.

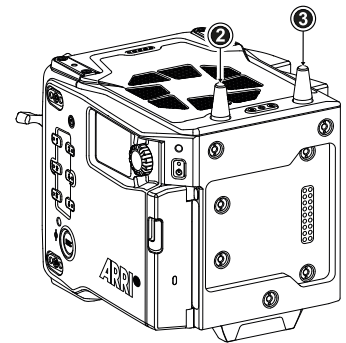

ADVICE

i

Electrostatic Discharge on Open Connector.

The WiFi module might be damaged by electrostatic discharge when leaving the connector without antenna attached.

- ▶ Do not leave the antenna connectors open during operation or transport.
- ▶ Use only the type of antenna originally supplied.

20.1 WiFi Settings

WiFi Power

- ▶ Select *MENU > System > Network / WiFi > WiFi Power* or
- ▶ Select *Side Display > Settings > WiFi* to enable/disable WiFi.

WiFi Mode

The WiFi module of the camera can be configured to act as an access point or in infrastructure (client) mode and opens up a wireless network in the 2.4 GHz band.



- ▶ Select *MENU > System > Network / WiFi > WiFi Mode*.
- The WiFi mode can only be changed while WiFi power is disabled.

Following options are available:

Host The camera acts as an WiFi access point. The SSID of the camera is ALEXA35-xxxxx. (xxxxx is the five digit serial number of the camera)

Client The camera can connect to a WiFi network and receives it's IP address via DHCP.

Icons on the HOME screen and the Status Info indicate the WiFi status:

-  Host mode is enabled.
-  Client mode is enabled, connection to a network has been established.
-  Client mode is enabled, camera is not connected to a network.

WiFi Password (Host Mode)

The camera requires a password when connecting to it via WiFi. The default password is “arriarri”.

- ▶ Select *MENU > System > Network / WiFi > WiFi Host Password* to set the WiFi password. The WiFi password must be between 8 and 32 characters long.

WiFi Host Channel

- ▶ Select *MENU > System > Network / WiFi > WiFi Host Channel*.
- ▶ Select *Automatic* to have the camera automatically select the WiFi host channel with the best performance, or select a WiFi channel between 1 and 11.

With the *Automatic* setting, the camera will rediscover the best WiFi host channel each time the camera is booted or WiFi is turned on. Select *Automatic* from the list again to trigger a new scan.

When using WiFi and [White Radio](#) simultaneously, it is important to configure the used channels to avoid interference and guarantee optimal performance. The following table gives an overview of suitable channel configurations:

WiFi Channel	ARRI White Radio Channel													
	0	1	2	3	4	5	6	7	8	9	10	11	12	13
1	X	X	✓	✓	✓	✓	✓	✓	X	✓	✓	✓	✓	✓
2	X	X	✓	✓	✓	✓	✓	✓	X	X	✓	✓	✓	✓
3	✓	X	X	✓	✓	✓	✓	✓	X	X	✓	✓	✓	✓
4	✓	✓	X	X	✓	✓	✓	✓	X	X	✓	✓	✓	✓
5	✓	✓	X	X	✓	✓	✓	✓	✓	X	X	✓	✓	✓
6	✓	✓	X	X	✓	✓	✓	✓	✓	✓	X	X	✓	✓
7	✓	✓	✓	X	X	✓	✓	✓	✓	✓	X	X	✓	✓
8	✓	✓	✓	✓	X	X	✓	✓	✓	✓	X	X	✓	✓
9	✓	✓	✓	✓	X	X	✓	✓	✓	✓	✓	X	X	✓
10	✓	✓	✓	✓	X	X	✓	✓	✓	✓	✓	✓	X	X
11	✓	✓	✓	✓	✓	X	X	✓	✓	✓	✓	✓	X	X
	12	13	16	17	20	21	24	25	14	15	18	19	22	23

ZigBee IEEE 802.15.4 Radio Channel Number

Connect to a Network (Client Mode)

- ▶ Select *MENU > System > Network / WiFi > WiFi Network* and select the desired network from the list.
If the selected WiFi network uses encryption, you are prompted to enter the password.
- ▶ Enter the password and press *CONNECT*.

Connect to a Network using a QR Code (Client Mode)

You can use a QR code to connect to a WiFi network. The WiFi credentials need to be provided in the following format:

WiFi:S:my-ssid;T:[WEP|WPA|WPA2];P:my-password;;

where the italic parts need to be replaced with your network credentials.

- ▶ Select *MENU > System > Network / WiFi > WiFi Network > SCAN QR*.
- ▶ Hold the QR-Code in front of the lens so that it fills the frame and is in focus.
A popup window with QR-Code data is displayed.
- ▶ Press *CONNECT*.

Info: QR Code scanning is not available with the Camera Control Monitor CCM-1.

Disconnect from Network (Client Mode)

- ▶ Select *MENU > System > Network / WiFi > WiFi Network*.
- ▶ Press *DISCONNECT*.

If the network you were connected to is hidden, it will disappear from the network list shortly after.

20.2 Ethernet Settings

LAN IP Mode

- ▶ Select *MENU > System > Network / WiFi > LAN IP Mode*.

Following options are available:

Static	Select for manually entering an IP address and subnet mask.
DHCP	Select to let the camera accept a dynamically assigned IP address from an DHCP server.

LAN Static IP

- ▶ Select *MENU > System > Network / WiFi > LAN Static IP* to set the desired LAN Static IP address.

LAN Static Subnet

- ▶ Select *MENU > System > Network / WiFi > LAN Static Subnet* to set the desired LAN Static subnet.

LAN Static Gateway

- ▶ Select *MENU > System > Network / WiFi > LAN Static Gateway* to set the desired LAN Static gateway.

20.3 Streaming Metadata

The camera supports to stream real time metadata via Ethernet, to be used in virtual studios (aka volumes with an LED wall, aka mixed reality production systems). For more information please refer to the ARRI Live Link Metadata Manual, available in the [Technical Downloads](#) section on the ARRI website.

Streaming Addressing

- ▶ Select *MENU > System > Network / WiFi > Streaming Metadata > Streaming Addressing* to set the type of addressing.

Following options are available:

Unicast	The metadata is transmitted from the camera to an endpoint via any nodes.
Multicast	The metadata is transmitted to multiple recipients or to a closed group of recipients.

Streaming Address

- ▶ Select *MENU > System > Network / WiFi > Streaming Metadata > Streaming Address* to set the destination IP address.

Info: When streaming addressing is set to Multicast, the allowed address range is within IP subnet 239.192.0.0/16.

Streaming Port

- ▶ Select *MENU > System > Network / WiFi > Streaming Metadata > Streaming Port* to set the destination port between 1024 and 65535.

Enable Streaming

- ▶ Select *MENU > System > Network / WiFi > Streaming Metadata > Enable Streaming* to enable metadata streaming.

21 Metadata

An ARRI camera automatically collects metadata when shooting. This metadata is stored in the header of recorded MXF/Apple ProRes and MXF/ARRIRAW files. The data is also stored in separate Avid Log Exchange ALE files, which keep track of all statics that are recorded on one recording media. Additionally, ARRI cameras can record lens data dynamically frame-by-frame. Metadata can be accessed, visualized and exported directly in the ARRI Reference Tool.

For more information about ARRI camera metadata, please refer to the ARRI Metadata White Paper, available in the [Technical Downloads](#) section on the ARRI website.

Production Metadata in Camera Menu

- ▶ Select *MENU* > *Metadata* > to enter production metadata.

22 Lens & Electronic Control System (ECS)

22.1 Lens Data

ARRI Lens Data System (LDS)

The Lens Data System (LDS) allows ARRI cameras and accessories to identify connected lenses and exchange dynamic lens data reflecting the current lens settings. It works with cine lenses using ARRI LDS or LDS-2 technology, lenses using Cooke /i technology and even cine lenses without lens data capabilities. LDS also offers basic support for most B4 or PL ENG lenses and Canon photo lenses when used with the appropriate mount. Available lens information can be displayed live on lens control units like the Hi-5 or WCU-4, in the camera's viewfinder and on the monitoring outputs. It is sent with very low latency via Ethernet for use in mixed reality/virtual production environments and embedded as ancillary data in the SDI output. Post production benefits from frame accurate dynamic (per frame) and static (per clip) lens data in all original camera files.

Lenses with ARRI LDS Technology

Most ARRI lenses following the ARRI/Zeiss Ultra Prime LDS have built-in LDS functionality. This offers basic lens information and accurate lens tables for the Focus, Iris, and Zoom axis (if applicable). LDS lenses have integrated encoders for each axis and therefore deliver lens metadata even if the lens is adjusted manually. LDS-2 is the latest generation of the lens data system. It was introduced with the LPL mount and ARRI Signature Prime and Signature Zoom lenses. LDS-2 offers more bandwidth, higher precision and faster communication. LDS-2 requires no calibration turn to the end stops of each lens ring to deliver data. LDS-2 is prepared for future applications and is being licensed to other lens and camera manufacturers.

Lenses with Cooke /i Technology

Many lenses, camera and lens control system manufacturers rely on /i Technology, which has been designed and developed by Cooke Optics as an open lens metadata protocol. Every ALEXA camera with an LDS capable lens mount, including the original ALEXA "Classic", supports basic /i Technology. Please note that some older Cooke lenses may be running on outdated firmware. This is likely to cause incompatibilities with the LDS. Please contact Cooke Optics directly for more information about checking the lens firmware version and available updates.

Lenses without Lens Data Capabilities

To get the FIZ information for a lens without lens data capabilities, the LDS can derive the lens ring positions based on end-to-end calibrated lens motor positions and a lens file that is used as a look up table. These files are available from the Lens Data Archive (LDA), a local library of lens files, which can also be extended by the user. The LDA exists in ARRI cameras or accessories like the UMC-4, RIA-1, or cforce mini RF or in the ECS sync app for iOS.

To create a new lens file, you need a camera, lens motors, a HI-5 or WCU-4 wireless lens control unit and the lens. First, the motors are calibrated to the end stops of their lens rings. Then, axis by axis, the lens control is used to drive the lens to each marking on the lens barrel and to set markers for the corresponding motor (encoder) position. Finally, the lens file can be stored by e.g. model, focal length and optionally lens serial number. Programming a lens file takes a while, but is time well spent, as it can be shared between LDAs and therefore only needs to be done once.

ARRI Lens Data Mount

Certain non-LDS lenses can be retrofit with an ARRI Lens Data Mount (LDM-2), which is programmed with the lens file. Using a Lens Data Mount instead of the LDA is more practical where one lens may be used on many cameras, such as a camera rental operation. It also saves time in production as the LDS automatically uses the file when the lens is attached.

The LDM-2 is available for Angénieux Optimo 24-290, Angénieux 17-102, Angénieux 25-250, Cooke 25-250, Cooke 18-100 and Zeiss Apo Tessar 300.

Lens Data Display in Camera

Lens data can be displayed as camera status overlays in the viewfinder and the SDI outputs. Single overlays for focus distance, iris and focal length are displayed. For further information please see "[Configuration of Status Info Components](#)".

The camera can be configured to display either metric or imperial readings:

- ▶ Select *MENU > Lens & ECS > Focus Unit* to set the desired focus unit.

Following options are available:

Lens Default	Focus unit is displayed according to the markings on the lens (requires LDS or Cooke /i lens).
Imperial	Focus unit is displayed in Feet.
Metric	Focus unit is displayed in Meter.

Circle of Confusion

- ▶ Select *MENU > Lens & ECS > Circle of Confusion* to set the Circle of Confusion.

Following options are available:

0.009
0.013
0.025

22.2 Lens Data Archive

The Lens Data Archive (LDA) is an archive that contains lens tables. In combination with the lens motor(s) these lens tables provide lens data for lenses without a lens data interface. The lens tables set the raw motor encoder values in correlation to the actual lens scales. Once you choose the right lens table from the Lens Data Archive and calibrate your lens motors, you get the same type of lens data as an LDS lens would deliver. You can create your own lens tables for any given lens with the Hi-5 or WCU-4 hand units and save them internally, externally to a memory stick, or in an iOS device with the ECS Sync App. Lens tables can then be transferred wirelessly from the hand units to the camera.

Adding Lens Tables from the USB Medium

- ▶ Select *MENU > Lens & ECS > Lens Data > Lens Tables Installed > ADD*.
- ▶ Press *IMPORT* to import lens tables from a USB medium or *DEFAULTS* to select a lens table from the internal lens tables default list.
- ▶ Select the desired lens table from the list and press *IMPORT*.

The lens table is imported to the camera's Lens Tables Installed list.

- ▶ To use the lens table, select the lens table from the Lens Tables Installed list and press *SET*.

Some lens tables contain different scale classes for the same lens model. The scale class of an individual lens is engraved on the lens barrel. If required: select the corresponding scale class from the list.

It is possible to load a lens table even when an LDS lens is attached. The LDA values calculated from motor positions and lens tables take precedence over the values communicated by the lens itself. This can be necessary if the lens data from the lens is faulty or imprecise.



As soon as an LDA table is activated, the LDS contacts of the lens mount are switched off, indicated through the LDS icon on the HOME screen and in the Status Info.

Lens Tables Favorites List

Frequently used lens tables can be added to a favorites list. The list shows all lenses that have been added before, including the selected scale class.

Add Lens Tables to the Favorites List

- ▶ Select *MENU > Lens & ECS > Lens Data > Lens Tables Installed* and select and set a lens table for use.
- ▶ Select *MENU > Lens & ECS > Lens Table > Add to Favorites* to add the lens table to the favorites list.

Select a Lens Table from the Favorites List

- ▶ Select *MENU > Lens & ECS > Lens Data > Lens Table Favorites* and select and set a lens table from the list.

22.3 White Radio Configuration

The camera has an integrated radio unit via which the ARRI HI-5, WCU-4 and SXU-1 hand held units can be connected to the camera. It enables wireless lens control, lens data communication and remote control of basic camera functions. The radio system is referred to as white radio. The connector for the white radio antenna is located on the right side of the camera (1).

In order to assume a correct wireless operation, please ensure that the white radio antenna is installed correctly on the camera.

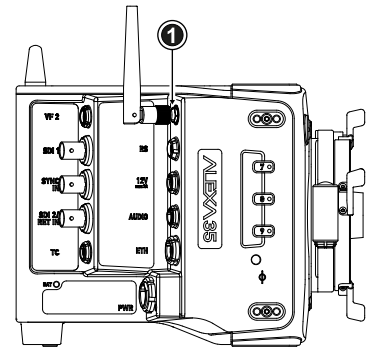

ADVICE

Electrostatic Discharge on Open Connector.

The White Radio module might be damaged by electrostatic discharge when leaving the connector without antenna attached.

- ▶ Do not leave the antenna connectors open during operation or transport.
- ▶ Use only the type of antenna originally supplied.

Radio Power and Radio Channel

- ▶ Select *MENU > Lens & ECS > Radio > Power* to enable white radio.
- ▶ Select *MENU > Lens & ECS > Radio > Channel* to select the white radio channel.

Following options are available:

Channel	Frequency	ZigBee IEEE 802.15.4 Channel	Channel	Frequency	ZigBee IEEE 802.15.4 Channel
0	2.410 GHz	12	7	2.475 GHz	25
1	2.415 GHz	13	8	2.420 GHz	14
2	2.430 GHz	16	9	2.425 GHz	15
3	2.435 GHz	17	10	2.440 GHz	18
4	2.450 GHz	20	11	2.445 GHz	19
5	2.455 GHz	21	12	2.460 GHz	22
6	2.470 GHz	24	13	2.465 GHz	23

Y7 Active white radio and set channel number is indicated through the white radio icon displayed on the HOME screen as well as in the Status Info.

To connect a hand unit to the camera set the hand unit's radio channel to the same value. Make sure that each camera on set uses its own white radio channel. It is not supported that one hand unit connects to two cameras in parallel.

Info: When using white radio and WiFi simultaneously it is important to configure the used channels to avoid interference and guarantee optimal performance. See the channel configuration table in the WiFi chapter "[WiFi Host Channel](#)" for more information.

► *MENU > Lens & ECS > Radio > Status* shows the current status of the white radio module:

- Off** White Radio is disabled.
- Init** White Radio is initializing
- Ready** White radio is initialized and ready to be used.
- Blocked** Selected White Radio channel is already used by another camera on set.

► *MENU > Lens & ECS > Radio > Connected Devices* displays the amount of hand units connected to the camera. Up to three hand units can connect to one camera in parallel.

Region Setting

The wireless region setting specifies the region the white radio can be used in compliance with local regulations.

► Select *MENU > Lens & ECS > Radio > Wireless Region Setting* to set the region.

The following options are available:

- | | | | |
|------------------|--------------------|---------------------|--------------|
| Australia | India | South Africa | World |
| Canada | Israel | South Korea | |
| China | Japan | Taiwan | |
| Egypt | New Zealand | Thailand | |
| Europe | Philippines | UAE | |
| Hong Kong | Singapore | USA | |

► Select *World* if your specific region is not listed.

ADVICE
Please ensure that the region is configured correctly, as it may be illegal to use White Radio in a region other than specified in the setting. All settings are compliant to FCC and IC regulations.

22.4 Lens Motors

The camera supports the use of cforce mini, cforce plus and cforce mini RF lens motors. Lens motors are connected to the LBUS connector of the camera and/or the lens mount and can be daisy chained. For more information about lens motors, please download the lens motor user manuals from the [Lens Motors](#) section of the ARRI website.

Motor Calibration

⚠ CAUTION



Rotating Lens Motor
Risk of crushing fingers and capturing and unraveling long hair, jewelry and/or clothing.

- ▶ Make sure that the lens motor is properly attached to the lens.
- ▶ Do not touch the lens motor gears while they are moving.
- ▶ Keep hair and loose clothing away from the motor gear teeth.
- ▶ Keep cables connected to the camera away from the motor gear teeth.
- ▶ Do not trigger a calibration unless all connected motors are attached to the lens.

After a lens motor has been connected to the camera, it must first be calibrated before it can be used.

 The camera indicates the calibration request by displaying an orange CAL icon on the HOME screen as well as in the Status Info. The icon turns gray once calibration is in progress, and expires when calibration has finished.



- ▶ Select *MENU > Lens & ECS > Calibrate All Motors* to start calibration of all connected lens motors. Alternatively, motor calibration can be triggered via the hand unit or the motor itself.

Motor Torque

- ▶ Select *MENU > Lens & ECS > LBUS Lens Motor Configuration Focus / Iris / Zoom Motor Torque* to set the torque of a lens motor in the range of **1** (the lowest torque) to **4** (the highest torque).

Motor Direction

- ▶ Select *MENU > Lens & ECS > LBUS Lens Motor Configuration Focus / Iris / Zoom Motor Direction* to set the motor direction between **Left** and **Right**.

Use *Left* if a lens motor is to the left of the lens, use *Right* if it is to the right.

Teeth Count

The motor teeth count setting is only active when an LDA lens table is active and is used to assure correct lens table mappings when using a different motor gear than the one the lens table was initially created with. The number of teeth can be read on the gear wheel of the motor.

- ▶ Select *MENU > Lens & ECS > LBUS Lens Motor Configuration Focus / Iris / Zoom Motor Teeth Count* to set the teeth count.

Following options are available:

- Auto** The camera determines the teeth count during motor calibration.
- 40t** The motor is equipped with a 40 tooth gear.
- 50t** The motor is equipped with a 50 tooth gear.
- 60t** The motor is equipped with a 60 tooth gear.

22.5 Changing a Lens

ADVICE



Risk of damage and injury when using lenses exceeding the supported entry depth!

LPL mount lenses with more than **30.00 mm** entry depth and PL mount lenses with more than **38.00 mm** entry depth might damage the camera's internal filters. Shards from broken filter glass might cause injury.

- ▶ Do not use LPL mount lenses with more than 30.00 mm entry depth.
- ▶ Do not use PL mount lenses with more than 38.00 mm entry depth.
- ▶ Use only lenses that do not exceed the following dimensions (left: LPL mount lenses, right: PL mount lenses):

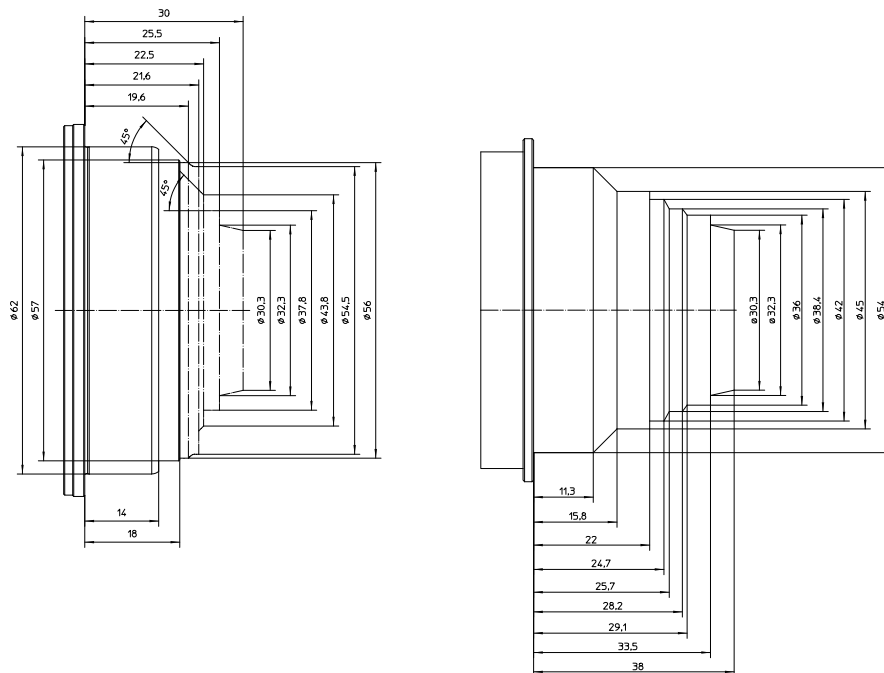

- ▶ To ensure maximum allowable lens mounting depth always have your camera and lenses shimmed correctly.

ADVICE



Dust particles on the sensor cover glass may affect the recorded image!

When no lens or lens cap is attached to the camera, dirt and dust particles may enter the camera and settle on the sensor cover glass. Particles on the sensor cover glass can later be visible in the recordings made by the camera.

- ▶ Changing lenses or lens mounts should be done in a dry and dust free environment. If this is not possible, take extra care that no particles enters the camera while the lens or the lens mount is off.
- ▶ After removal of a lens, perform a dust check to make sure no particles have settled on the sensor cover glass.
- ▶ Place the protective cap on the lens mount, when no lens is attached to the camera.
- ▶ Always store the camera with a capped lens mount or camera front cover installed.
- ▶ Make sure to protect all optical surfaces when changing a lens or lens mount.

ADVICE



Heavy Lenses may affect the flange focal depth!

Using lenses above 3 kg / 6.6 lbs without a proper lens support can put stress on the lens mount and affect the flange focal depth.

- ▶ Always use a suitable lens support for lenses weighing more than 3 kg / 6.6 lbs.

Lens change on the LPL mount, the PL mounts as well as the PL-to-LPL Adapter works the same way. The description below shows an LPL mount.

- ▶ When removing a lens, hold the lens securely.
- ▶ Turn the bayonet ring (1) anticlockwise until it stops.
- ▶ Gently remove the lens / lens port cap from the lens mount.

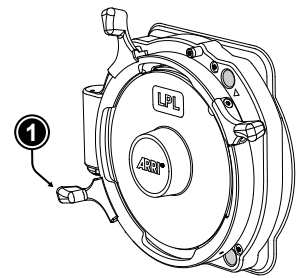

- ▶ Carefully insert the lens into the lens mount. Align the notch in the lens flange (1) with the index pin on the lens mount (2), keeping the lens rotated into a position where the lens markings are visible from either side of the camera.
- ▶ When attaching an LDS lens, make sure it is oriented so that the LDS contacts of the lens and lens mount (4) meet (12:00 position). Do not touch the LDS contacts.
- ▶ Carefully press the lens flange flat onto the lens mount.
- ▶ Turn the bayonet ring (3) clockwise until the lens is locked securely.

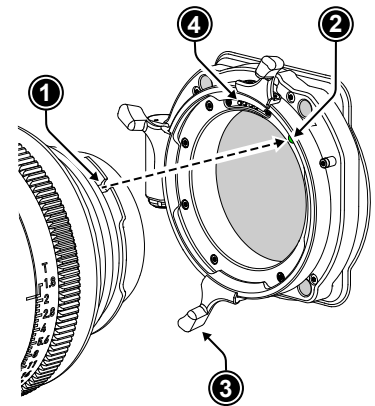

22.6 EF Lens Iris Adjustment

When using EF Mount and EF lenses, the aperture of the lens can be controlled from the camera menu. This option is only available when the camera is equipped with an EF Mount. Furthermore, the iris of EF lenses can be controlled using the ARRI Master Grips or the Operator Control Unit OCU-1.

- ▶ Select *HOME > EI > Iris*.
- ▶ Rotate the jogwheel to open or close the iris of the EF lens. Press the jogwheel to toggle between full stops and sub stops.

Info: Sub stop precision depends on the lens type and is automatically set by the camera.



User Buttons *EF Close Iris* and *EF Open Iris* support to quickly adjust the iris of an EF lens.

22.7 Enable Lens Mount

You can disable the LDS contacts of the lens mount. Usually this is not necessary, but it can be helpful when e.g. lenses with faulty lens data are used. Please note that as soon as an LDA lens table is activated, the LDS contacts of the lens mount are switched off automatically. There is no need to switch the mount off manually when using LDA lens tables.

- ▶ Select *MENU > Lens & ECS > Enable Lens Mount* to enable/disable the lens mount contacts of the lens mount.



A disabled lens mount is indicated through the LDS icon on the HOME screen as well as in the Status Info.

23 Remote Control

23.1 Web Remote

The camera can be remotely controlled via WiFi or Ethernet using the camera's Web Remote feature.

- ▶ Connect the camera to your computer via WiFi or Ethernet.
- ▶ Open a web browser and enter the URL ALEXA35-xxxxx.local (replace xxxxx with the camera's 5-digit serial number).

To use the Web Remote via this URL, the device must support zero-configuration networking (zeroconf), e.g. through Apple Bonjour. Without zeroconf, the Web Remote can be reached via the network's IP address (WiFi or LAN IP). The WiFi IP is fixed to 192.168.153.1. The LAN IP can be either assigned from a DHCP server or configured manually, and can be checked in *MENU > Info > Network Info* or the Info page of the side display.

HOME

Shows the camera HOME screen (as on MVF-2) with access to the main parameters.

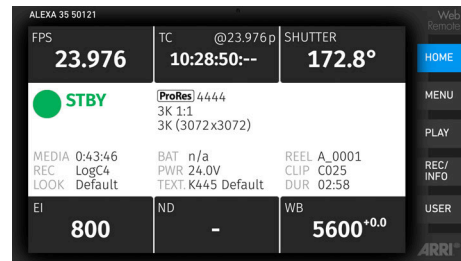

MENU

Access to the camera menu.

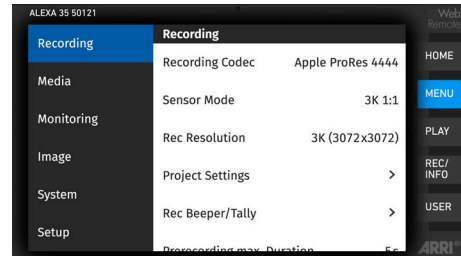

PLAY

Starts playback from the recording medium. Provides the same controls as the MVF-2, but does not show a video signal.

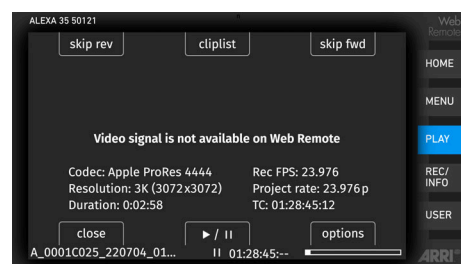

REC / INFO

Contains information on the main recording parameters, plus a REC button. Click the big circle icon to start/stop recording.

Info: Rec status and timecode may respond slightly delayed depending on the network's speed.

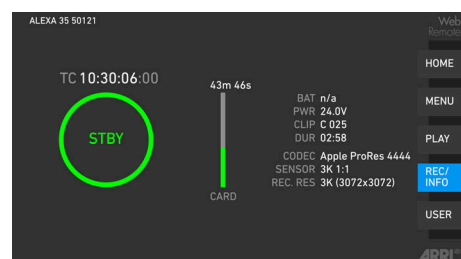

USER

Shows configuration of the camera user buttons and allows you to trigger them. Press the number icons to trigger the user buttons.

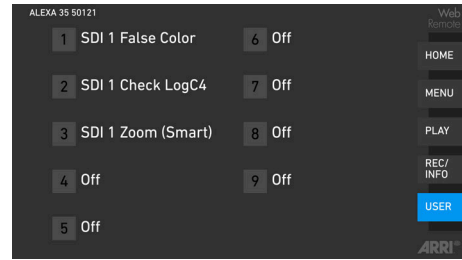

ADVICE

Frequent reloading of the Web Remote camera interface connected with WiFi indicates a limited WiFi range. Please place the device closer to the camera or connect via Ethernet. You may also consider to use the WiFi client mode which allows connecting the camera to a WiFi network.

After a camera update, the Web Remote feature may not be fully functional until the browser cache of your web browser has been cleared. Always use a 'private' or 'incognito' browser window when using the Web Remote to operate the camera and to perform a SUP update. This prevents possible erroneous behavior.

23.2 Camera Access Protocol (CAP)

The Camera Access Protocol (CAP) is an IP based API used to control and monitor ARRI cameras via a network connection. The protocol incorporates functions to perform color grading, query and set values like exposure index or sensor frame rate, start and stop recording and many more. Information on the Camera Access Protocol is available through the ARRI Partner Program free of charge. For more details please see our [ARRI Partner Program](#) and the Camera Access Protocol Feature List in the [Technical Downloads](#) section on the ARRI website.

Activation of CAP Server

- ▶ Select *MENU > System > Camera Access Protocol (CAP) > Enable CAP Server* to switch remote access to the camera via the Camera Access Protocol on or off.

CAP Server Password

- ▶ Select *MENU > System > Camera Access Protocol (CAP) > Cap Server Password*.
- ▶ Use the on-screen keyboard to enter a password used for Camera Access Protocol connections.

CAP Client List

The CAP client list shows the name of the currently connected client. The list shows 'NONE' if no client is connected, and 'NO NAME' if the connected client has not transmitted its name.

- ▶ Select *MENU > System > Camera Access Protocol (CAP) > CAP Client List* to display the list.

ADVICE

The Camera Control Monitor CCM-1 communicates with the camera using the CAP protocol. As soon as it is attached CAP Server will be switched to 'ON' automatically. For security reason we recommend modifying the CAP Server password when using the CCM-1. You are not required to enter the password on the CCM-1 as long as the connection is using the VF-Cable.

23.3 Camera Companion App

The Camera Companion App offers remote control of one or multiple cameras, as well as customization of the app's user interface. It focuses on the functions that are most frequently used during production. The app uses the Camera Access Protocol (CAP) via the camera's internal WiFi radio or the ETH interface. The app is available for download from the Apple App Store and can be used on iPhone, iPad, M1 and M2 Mac computers and the Apple watch.

23.4 Hand Units Hi-5 and WCU-4

The ARRI hand units Hi-5 and WCU-4 support to control basic settings of the camera. The following settings can be accessed through the hand units:

Rec start/stop	White Balance	False Color
Full Playback Control	ND Filter	Frame Lines
Sensor Frame Rate	Peaking	User Buttons
Shutter Angle	Surround View	User Setups
Exposure Index	Status Info	

24 ALEXA 35 Accessories

24.1 Lens Mounts



ARRI LPL Mount (LBUS) K2.0018983

A lens mount specifically designed for large format and/or full frame lenses with an LPL (Large Positive Lock) mount. Compatible with ARRI LDS-2 and Cooke /i. Can be equipped with the PL-to-LPL Adapter to accept PL mount lenses. Includes an LBUS connector for cforce-type lens motors. In comparison to the PL mount, the LPL mount has a wider diameter (62 mm vs. 54 mm) and a shorter flange focal distance (44 mm vs. 52 mm). Optimized for the increased dynamic range of the ALEXA 35 sensor.



PL-to-LPL Adapter K2.0016936

An adapter that can be used to attach PL mount lenses to a camera with an LPL mount. Compatible with ARRI LDS-1 and Cooke /i. The adapter can be mounted either so that the LDS contacts are in the 12:00 position for ARRI lenses, or so that the LDS contacts are in the 3:00 position for Cooke lenses.



PL Mount (LBUS) K2.0042651

A PL lens mount with an LBUS connector optimized for the increased dynamic range of the ALEXA 35 sensor. Reduced internal reflection properties ensure that the full contrast of the image from the lens reaches the sensor. The PL Mount (LBUS) is compatible with ALEXA 35, ALEXA Mini LF, ALEXA Mini and AMIRA, but only ALEXA 35, ALEXA Mini LF and ALEXA Mini support the LBUS connector. Replaces the older "Titanium PL LDS mount with LBUS (K2.0003216)".



PL Mount (Hirose) K2.0042652

A PL lens mount with a Hirose connector optimized for the increased dynamic range of the ALEXA 35 sensor. Reduced internal reflection properties ensure that the full contrast of the image from the lens reaches the sensor. The PL Mount (Hirose) is compatible with ALEXA 35, ALEXA Mini LF, ALEXA Mini and AMIRA. Replaces the older "PL LDS Lens Mount (Hirose) (K2.0001107)".



EF Mount (LBUS) K2.0019965

An EF lens mount with an LBUS connector optimized for the increased dynamic range of the ALEXA 35 sensor. Reduced internal reflection properties ensure that the full contrast of the image from the lens reaches the sensor. This EF Mount (LBUS) has a wide light baffle that illuminates both Super 35 and large format sensor areas. Allows control of the electronic iris in many EF lenses through the camera menu and ARRI ECS devices. Also allows the use of the electronic Image Stabilization found in some EF lenses.

24.1.1 Changing the Lens Mount

⚠ WARNING



Changing the Lens Mount while the Camera is Powered

Risk of electric shock and permanent damage to the camera and/or the lens mount.

- ▶ Always switch off the camera and disconnect all power supplies before changing the lens mount.

ADVICE



Dust particles on the sensor cover glass may affect the recorded image!

When no lens or lens cap is attached to the camera, dirt and dust particles may enter the camera and settle on the sensor cover glass. Particles on the sensor cover glass can later be visible in the recordings made by the camera.

- ▶ Changing lenses or lens mounts should be done in a dry and dust-free environment. If this is not possible, take extra care that no particles enter the camera while the lens or the lens mount is off.
- ▶ After removal of a lens, perform a dust check to make sure no particles have settled on the sensor cover glass.
- ▶ When no lens is attached to the camera, use the lens port cap to prevent dust from entering the lens cavity.
- ▶ Always store the camera with a capped lens mount or camera front cover installed.
- ▶ Make sure to protect all optical surfaces when changing a lens or lens mount.

ADVICE

When adjusting the flange focal depth on the LPL mount make sure to insert the shims in the correct orientation. Inserting the shims in the incorrect orientation (flipped) may result in a short circuit on the LDS print, compromising LDS functionality (lens detection and lens data).

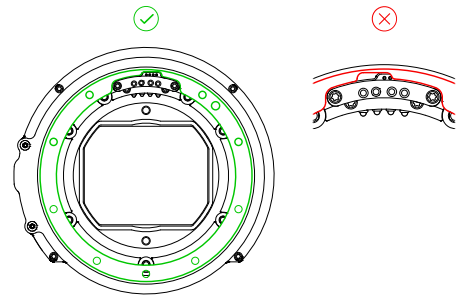

ADVICE

The Titanium PL LDS Mount with LBUS (K2.0003216), the AMIRA PL LDS Lens Mount (K2.0001107) and the EF Lens Mount (K2.0001103) are mechanically compatible with the ALEXA 35, but these lens mounts are not sufficiently stray light optimized to be used with the ALEXA 35.

New lens mounts specifically designed for the ALEXA 35 (PL Mount (LBUS) (K2.0042651), PL Mount (Hirose) (K2.0042652), EF Mount (LBUS) (K2.0019965) ensure that the high dynamic range of the sensor is not compromised by stray light that may be generated in the optomechanics of the camera.

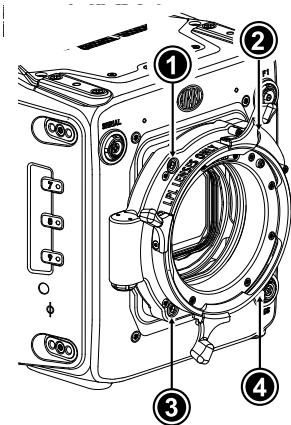

- ▶ Switch off the camera and unplug any power source.
- ▶ Crosswise, loosen all four lens mount screws with a 3.0 mm Allen key.
- ▶ Carefully remove the lens mount (or camera front cover).
- ▶ Store the lens mount in a case for dust protection.

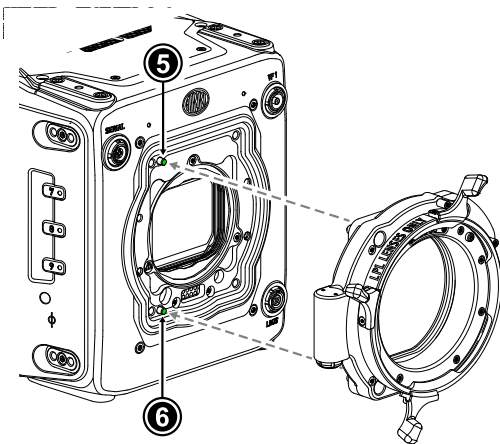

- ▶ Carefully align the lens mount with the two guiding pins (5, 6) on the camera's lens mount base.
- ▶ Crosswise, hand-tighten all four lens mount screws with a 3.0 mm Allen key.

24.2 Mechanical Accessories

24.2.1 Bottom Accessories



Balance Utility Dovetail BUD-1 K2.0034180

The super small and lightweight Balance Utility Dovetail BUD-1 attaches to the ALEXA 35 bottom. Once mounted to the camera, the BUD-1's wide dovetail allows the camera to be securely and quickly attached and detached from and to all ALEXA 35 accessories that sit below the camera including the CBP-5, CBP-6, BPA-6, CSP-2 and SAM-5 through 9.

Additionally, the dovetail allows balancing of the camera on the accessories. Use the lever to lock or unlock the sliding option. Push in the blue safety button to slide the ALEXA 35/BUD-1 off whatever it is mounted on. Furthermore, keeping the BUD-1 attached to the camera ensures that the camera's air intake is not covered.



Bridge Plate BP-8 K2.0031436

The venerable Bridge Plate BP-8 sits between a Bridge Plate Adapter and the ARRI bottom dovetail plate and allows balancing of the camera. The BP-8 accepts two 19 mm studio rods without restrictions regarding forward and backward positioning of the rods.

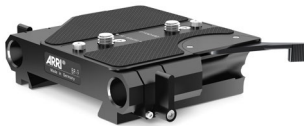

Bridge Plate BP-9 K2.0031435

The venerable Bridge Plate BP-9 sits between a Bridge Plate Adapter and the ARRI bottom dovetail plate and allows balancing of the camera. The BP-9 accepts two 15 mm studio rods without restrictions regarding forward and backward positioning of the rods.



Bridge Plate Adapter BPA-6 K2.0024745

While the Compact Bridge Plates represent the fastest, most comfortable and flexible method to change from tripod to shoulder and to other camera supports, the BPA-6 provides an option for those who want to use tripods with "Touch and Go" plates or the classic ARRI Bridge Plates BP-8 or BP-9. The BPA-6 dovetail slides into the bottom of the Balance Utility Dovetail BUD-1. The bottom of the BPA-6 is a "Touch and Go 35" plate that allows quick mounting to a variety of tripod heads.



Compact Bridge Plate CBP-5 K2.0023549

The CBP-5 is a compact and lightweight base plate that combines the features of a sliding studio bridge plate with a comfortable Visco shoulder pad. Its unique quick-release system allows the CBP to be lifted straight off (or placed on) the bottom dovetail plate without having to slide it off (on). The Compact Bridge Plates represent the fastest, most comfortable and most flexible method to change from tripod to hand held and to other camera supports. The CBP-5 accepts 19 mm studio rods and 15 mm Lightweight rods.



Compact Bridge Plate CBP-6 K2.0023836

The CBP-6 is a compact and lightweight base plate that combines the features of a sliding studio bridge plate with a comfortable Visco shoulder pad. Its unique quick-release system allows the CBP to be lifted straight off (or placed on) the bottom dovetail plate without having to slide it off (on). The Compact Bridge Plates represent the fastest, most comfortable and most flexible method to change from tripod to hand held and to other camera supports. The CBP-6 accepts 15 mm studio rods and 15 mm Lightweight rods.



Compact Shoulder Pad CSP-2 K2.0024161

The CSP-2 is a simple flat shoulder pad with a long, comfortable Visco pad. Its four (removable) metal feet allow the camera to be safely placed on any flat surface when not on the operator's shoulder. The CSP-2 slides into the bottom of the Balance Utility Dovetail BUD-1.



Bottom Plate 300 mm/12" K2.0015896

The 300 mm/12 inch Bottom Dovetail Plate is the standard for all prime lenses where minimal balancing is required.



Stabilizer Adapter Mount SAM-5 K2.0024572

The Stabilizer Adapter Mount SAM-5 is a sliding dove tail plate with a very small height that connects the ALEXA 35 to a MōVI Pro or M15. The SAM-5 top dove tail slides into the bottom of the Balance Utility Dovetail BUD-1. The SAM-5 bottom is a rail that slides into the top stage of the MōVI Pro or M15.



Stabilizer Adapter Mount SAM-6 K2.0024508

The Stabilizer Adapter Mount SAM-6 is a low profile sliding dove tail plate that connects the ALEXA 35 to ARRI CSS products, such as ARRI TRINITY and SRH-3/360. The SAM-6 top dove tail slides into the bottom of the Balance Utility Dovetail BUD-1. The SAM-6 bottom is a dove tail that slides into the top stage of any ARRI CSS product.



Stabilizer Adapter Mount SAM-7 K2.0024511

The Stabilizer Adapter Mount SAM-7 is a low profile sliding dove tail that connects the ALEXA 35 to ARRI Artemis and GPi PRO Stabilizers. The SAM-7 top dove tail slides into the bottom of the Balance Utility Dovetail BUD-1. The SAM-7 bottom is a dove tail that slides into the top stage of any stabilizer system using the GPi Pro standard (including the ARRI Artemis).

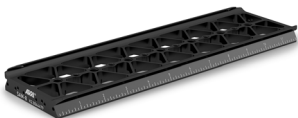

Stabilizer Adapter Mount SAM-8 K2.0044479

The Stabilizer Adapter Mount SAM-8 is a low profile sliding dove tail plate that connects the ALEXA 35 to Tiffen Steadicam products, such as M1 and M2. The SAM-8 top dove tail slides into the bottom of the Balance Utility Dovetail BUD-1. The SAM-8 bottom is a dove tail that slides into the stage of Tiffen Steadicams.



Stabilizer Adapter Mount SAM-9 K2.0041949

The Stabilizer Adapter Mount SAM-9 is a low profile sliding dove tail that connects the ALEXA 35 to DJI Ronin 2. The SAM-9 top dove tail slides into the bottom of the Balance Utility Dovetail BUD-1. The SAM-9 bottom is a dove tail that slides into the stage of DJI Ronin products.

24.2.2 Top Accessories



Low Mode Support LMS-4 K2.0034178

The Low Mode Support LMS-4 is a fully featured top plate for the ALEXA 35. A new quick release mechanism allows the CCH-5 top handle to be easily removed, without tools, while retaining superior rigidity while mounted. Dual rod clamps for optically centered 15 mm rods allow for top mounted motors or traditional viewfinder mounting brackets. Multiple mounting points support a range of accessories and low mode mounting for the ARRI Artemis and other mechanical stabilizers. For even more mounting options, the LMS-4 can be extended with the TEB-1.



Universal Adapter Plate UAP-3 K2.0034179

The Universal Adapter Plate UAP-3 is a small and flat staging platform for the ALEXA 35 top accessories, including the Lightweight Camera Handle LCH-1 and Center Camera Handle CCH-2. For more mounting options, the UAP-3 can be extended to the back with the TEB-1. The UAP-3 can also be attached to the base of the camera when an ultra slim mounting plate is required for small rigging scenarios.



Top Extension Bracket TEB-1 K2.0024062

The Top Extension Bracket TEB-1 extends the Low Mode Support LMS-4 or Universal Adapter Plate UAP-3, so more accessories, including the Rear Accessory Bracket RAB-2 and Articulated Mounting Plate AMP-1, can be mounted to the camera's top and back.



Lightweight Support LWS-6 K2.0023948

The LWS-6 holds two 15 mm lightweight support rods. It is designed as an option to add lightweight rods to the Lightweight Camera Handle LCH-1 or to the Universal Adapter Plate UAP-3. When attached, rods are optically centered based on the lightweight rod standard and allow mounting further accessories like the Mini Viewfinder Bracket MVB-1, lens motors or matte boxes.



Center Camera Handle CCH-5 K2.0023519

The Center Camera Handle CCH-5 is a full size production top handle that can be quickly attached and removed from the LMS-4 without tools. Featuring a wider, more comfortable grip than previous top handles the CCH-5 has been designed to allow common gimbal top plates to remain mounted to the camera, under the handle. Multiple mounting points adorn the handle for accessories and existing HEB and HEX handle extensions can be mounted to the front and rear.



Lightweight Camera Handle LCH-1 K2.0024066

The Lightweight Camera Handle LCH-1 is a lightweight carbon fibre top handle for carrying the ALEXA 35 and for mounting accessories. It can be quickly attached to or removed from the camera's top or the Universal Adapter Plate UAP-3 without tools, and the handle post can be slid forward and backwards in order to balance the camera in your hand.



Balance Harness Adapter BHA-1 K2.0034554

The Balance Harness Adapter BHA-1 allows the secure attachment and rapid balancing of the ALEXA 35 when using various camera suspension harnesses. The BHA-1 slips over the handle of the Lightweight Camera Handle LCH-1 and can be slid forwards and backwards with a simple thumbscrew. It features a 3/8-16 threaded hole for connection and can also be used to mount accessories to the top handle.



Viewfinder Mounting Bracket VMB-5 K2.0033859

The Viewfinder Mounting Bracket VMB-5 offers a longer reach than traditional viewfinder brackets and is the most flexible and comfortable method to attach a viewfinder to a camera. Positioning the viewfinder in a 360° arc is done by loosening a single thumb screw and freely repositioning the viewfinder, which will remain in place thanks to double friction based clamping mechanisms. The VMB-5 is compatible with all standard ARRI viewfinder extension brackets and viewfinder adapters. Requires SAS-1 for attachment to a camera.



Square Accessory Sleeve SAS-1 K2.0033733

The Square Accessory Sleeve SAS-1 is required to mount the VMB-5 to your camera and has been designed with a rectangular rod to prevent the viewfinder falling when loosening the adjustment clamp. The SAS-1 has been designed with the CCH-5 top handle in mind, but can be mounted to any two M4 attachment points spaced 20 mm apart, as regularly found on ARRI camera accessories.



Viewfinder Cross Pipe K2.0013302

The Viewfinder Cross Pipe can be used in combination with the RMB-3 or RMB-7 to create a basic, simple viewfinder mounting bracket.



Mini Viewfinder Bracket MVB-1 K2.0006140

The Mini Viewfinder Bracket MVB-1 allows the MVF-1 viewfinder to attach to the ALEXA Mini and it allows the MVF-2 viewfinder to attach to the ALEXA 35 or ALEXA Mini LF. This is the traditional viewfinder mounting method found on ALEXA, ALEXA Mini and ALEXA Mini LF cameras.



The Adjustable Top Plate for MōVI (K2.0024181)

The Adjustable Top Plate for MōVI connects any top accessory plate with two 3/8-16 or two 1/4-20 attachment points quickly to a MōVI Pro or M15 rig.



Monitor Arm for Camera MAC-1 (K2.0048394)

The two-axis MAC-1 monitor arm allows for rapid positioning of the Camera Control Monitor CCM-1 without affecting the horizon relative to the camera. The MAC-1 features an adjustable friction system for one-handed repositioning and inserts for ARRI 1/4" Pin-Lock and SmallHD mounting standards.

**Viewfinder Adapter VFA-4 (K2.0048510)**

The VFA-4 enables mounting of the Camera Control Monitor CCM-1 to standard ARRI viewfinder brackets without tools, and comes with inserts for ARRI 1/4" Pin-Lock and SmallHD mounting standards. A folding mechanism allows quick repositioning and flat storage of the CCM-1.

24.2.3 Side Accessories



Camera Side Bracket CSB-1L K2.0033573

The Camera Side Bracket CSB-1L allows mounting of accessories to the left side of the ALEXA 35. It features an ARRI rosette for hand grips and multiple 1/4-20, 3/8-16 and M4 mounting holes.



Camera Side Bracket CSB-1R K2.0033571

The Camera Side Bracket CSB-1R allows mounting of accessories to the right side of the ALEXA 35. It features an ARRI rosette for hand grips and multiple 1/4-20, 3/8-16 and M4 mounting holes. It can be extended with the Camera Side Bracket CSB-1R Extension (K2.0034189).



Camera Side Bracket CSB-1R Extension K2.0034189

The Camera Side Bracket CSB-1R Extension is an extension to the Camera Side Bracket CSB-1R, providing additional attachment points. It features multiple 1/4-20, 3/8-16 and M4 mounting holes. It attaches to the CSB-1R with two Torx T8 screws.



Articulated Mounting Plate AMP-1 K2.0034182

The Articulated Mounting Plate AMP-1 is a hinged plate that allows accessories to be mounted in locations that would have previously prevented access to various camera ports. The AMP-1 allows further adjustment up/down in relation to its attachment bracket. It is compatible with any accessory with a 1/4-20, 3/8-16 or M4 attachment point and is particularly suited to video transmitters and motor controllers.



Rod Mounting Bracket RMB-3 K2.0006186

The Rod Mounting Bracket RMB-3 is a great method to attach an accessory support rod virtually anywhere on the camera, often used to provide a rod for lens motors by mounting the RMB-3 onto one of the side brackets. The RMB-3 can also be used to support the Viewfinder Cross Pipe for mounting viewfinders.



Rod Mounting Bracket RMB-7 K2.0023907

The Rod Mounting Bracket RMB-7 provides support for a single 19 mm support rod (or 15 mm with reduction insert K2.66255.0). Often used with lens motors, the RMB-7 is optimized for ARRI TRINITY and TRINITY 2. The RMB-7 mounts to M4 threads spaced 20 mm apart. The RMB-7 can also be used to support the Viewfinder Cross Pipe for mounting viewfinders.

RMB-3 and RMB-7 fulfill the same purpose, except that RMB-7 has a low profile design with a wing thumb screw underneath the rod holder, ensuring the ALEXA 35 with RMB-7 fits inside the ARRI Trinity.

24.2.4 Other Accessories



Rear Accessory Bracket RAB-2 K2.0034183

The Rear Accessory Bracket RAB-2 allows accessories to be mounted behind the ALEXA 35. This can be done for organizational reasons or to better balance the camera. The RAB-2's top attaches to the back side of the Top Extension Bracket TEB-1. The RAB-2's bottom attaches to the back side of the Balance Utility Dovetail BUD-1.



Vertical Format Baseplate K2.0042610

The Vertical Format baseplate allows shooting with the ALEXA 35 on its side for Portrait ("9:16") and attaches to the ALEXA 35's right side and interfaces with Compact Bridge Plates, Bridge Plate Adapters, Shoulder Pads and the Stabilizer Adapter Mounts.



Vertical Top Plate K2.0043666

The Vertical Top Plate attaches to the ALEXA 35's left side and acts as a top plate to support the lightweight Camera Handle LCH-1.



Case for ALEXA 35 K2.0040234

The Case for ALEXA 35 support the camera in various rigging configurations and has cut-outs that fits specific support accessories, recording media and media readers. The case features two large pockets for additional accessories.

24.3 Electronic Accessories



Audio Extension Module AEM-1 K2.0023750

The Audio Extension Module AEM-1 adds a high-quality audio interface and extra accessory power outputs to the ALEXA 35. Featuring two ultra-low noise microphone pre-amplifier channels, the AEM-1 mounts directly to the rear of the camera as an integrated electronic module. Selectable features include MIC/LINE input, 48V Phantom power, phase reversal, adjustable low-cut filter, gain and limiter. The AEM-1 also features an AES stereo digital audio input and a high quality Headphone amplifier.



Power Distribution Module PDM-1 K2.0024101

The Power Distribution Module PDM-1 adds seven power outputs (4x 24 V, 2x 12 V, 1x 12 V Twist D-Tap) to the camera. Once attached, the PDM-1 is internally powered and there are no extra cables or brackets necessary, making it an elegant integrated accessory.



External Power Adapter EPA-1 K2.0034205

The EPA-1 allows a camera mounted to a stabilizer rig to be externally powered by a block battery instead of the stabilizer's batteries during breaks in shooting. As the camera's main PWR connector is usually occupied by the stabilizer power cable, the EPA-1 can be quickly attached to a B-Mount battery adapter to offer a second LEMO 8-pin PWR connector.

24.4 Battery Adapters



B-Mount Battery Adapter K2.0023751

The B-Mount Battery Adapter attaches into the recessed area at the back of the camera, the Power Distribution Module PDM-1 or the Audio Extension Module AEM-1 and provides compatibility with any B-Mount battery.



Battery Adapter Back BAB-LF K2.0034204

The Battery Adapter Back BAB-LF attaches into the recessed area at the back of the ALEXA 35, the Power Distribution Module PDM-1 or the Audio Extension Module AEM-1 and offers an interface to alternative on-board battery systems originally intended to use with the ARRI ALEXA LF.

ALEXA 35 Components Overview

January 22, 2023. This shows **new ARRI articles** for the ALEXA 35 and some **existing ARRI articles**. Cables are not shown.
 (1) UAP-3 can also mount to the camera's bottom. But if the LWS-6 is then attached, the rods' distance to the camera's optical center is off.
 (2) Remove the "Touch and Go 35" plate at the bottom of the BPA-6 before attaching BP-8 or BP-9.

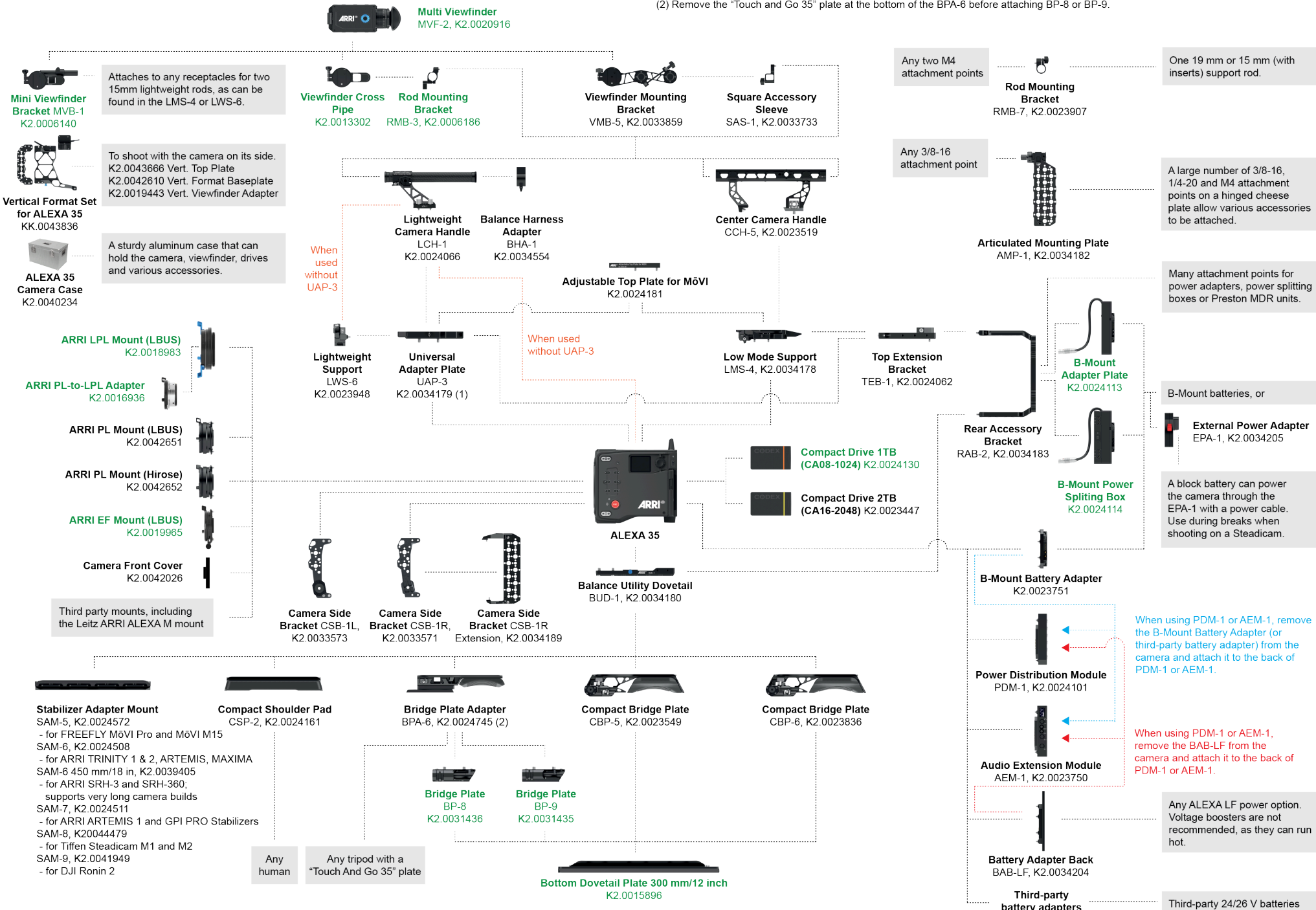

25 Appendix

25.1 Data Rates, Recording Times and Max. FPS

Sensor Mode	Recording Resolution	Data Rate @ 24 fps (incl. audio)	Rec Time @ 24fps (hh:mm)		Max. FPS	
			1 TB	2 TB	1 TB	2 TB
4.6K 3:2 Open Gate	4.6K (4608 x 3164)	2.009 GB/h (ARRIRAW)	00:28	00:56	35 fps	75 fps
		633 GB/h (Apple ProRes 422 HQ)	01:30	03:01	60 fps	60 fps
		945 GB/h (Apple ProRes 4444)	01:00	02:01		
		1.414 GB/h (Apple ProRes 4444 XQ)	00:40	01:21		
4.6K 16:9	4.6K (4608 x 2592)	1.648 GB/h (ARRIRAW)	00:34	01:08	45 fps	75 fps
	4K (4096 x 2304)	413 GB/h (Apple 422 HQ)	02:19	04:39	75 fps	75 fps
		615 GB/h (Apple 4444)	01:33	03:07		
918 GB/h (Apple 4444 XQ)	01:02	02:05				
4K 16:9	4K (4096 x 2304)	1.304 GB/h (ARRIRAW)	00:43	01:26	55 fps	120 fps
		413 GB/h (Apple 422 HQ)	02:19	04:39	100 fps	100 fps
		615 GB/h (Apple 4444)	01:33	03:07	100 fps	
	918 GB/h (Apple 4444 XQ)	01:02	02:05	90 fps		
	UHD (3840 x 2160)	413 GB/h (Apple 422 HQ)	02:38	05:16	120 fps	120 fps
		615 GB/h (Apple 4444)	01:46	03:32	120 fps	
918 GB/h (Apple 4444 XQ)	01:11	02:22	105 fps			
2K (2048 x 1152)	413 GB/h (Apple 422 HQ)	08:46	17:33	120 fps	120 fps	
	615 GB/h (Apple 4444)	06:00	12:01	120 fps		
918 GB/h (Apple 4444 XQ)	04:04	08:08				
HD (1920 x 1080)	413 GB/h (Apple 422 HQ)	09:53	19:47	120 fps	120 fps	
	615 GB/h (Apple 4444)	06:47	13:34	120 fps		
	918 GB/h (Apple 4444 XQ)	04:36	09:13			
4K 2:1	4K (4096 x 2048)	1.160 GB/h (ARRIRAW)	00:48	01:37	65 fps	120 fps
		368 GB/h (Apple 422 HQ)	02:36	05:13	120 fps	120 fps
		547 GB/h (Apple 4444)	01:45	03:30	120 fps	
		817 GB/h (Apple 4444 XQ)	01:10	02:20	100 fps	
3.8K 16:9	UHD (3840 x 2160)	1.144 GB/h (ARRIRAW)	00:49	01:38	65 fps	120 fps
3.3K 6:5	3.3K (3328 x 2790)	1.283 GB/h (ARRIRAW)	00:44	01:28	55 fps	100 fps
		406 GB/h (Apple 422 HQ)	02:21	04:43	75 fps	75 fps
		605 GB/h (Apple 4444)	01:35	03:10		
	904 GB/h (Apple 4444 XQ)	01:03	02:07			
4K 2.39:1 Ana 2x	310 GB/h (Apple 422 HQ)	03:06	06:12	90 fps	90 fps	
460 GB/h (Apple 4444)	02:05	04:10				
686 GB/h (Apple 4444 XQ)	01:23	02:47				

Sensor Mode	Recording Resolution	Data Rate @ 24 fps (incl. audio)	Rec Time @ 24fps (hh:mm)		Max. FPS	
			1 TB	2 TB	1 TB	2 TB
3K 1:1	3K (3072 x 3072)	1.304 GB/h (ARRIRAW)	00:43	01:26	55 fps	100 fps
		413 GB/h (Apple 422 HQ)	02:19	04:39	90 fps	90 fps
		615 GB/h (Apple 4444)	01:33	03:07		
		918 GB/h (Apple 4444 XQ)	01:02	02:05		
	3.8K 2:1 Ana 2x	324 GB/h (Apple 422 HQ)	02:57	05:55	100 fps	100 fps
		482 GB/h (Apple 4444)	01:59	03:59		
2.7K 8:9	UHD 16:9 Ana 2x	808 GB/h (Apple 4444 XQ)	01:11	02:22	100 fps	100 fps
		541 GB/h (Apple 4444)	01:46	03:32		
		364 GB/h (Apple 422 HQ)	02:38	05:16		
2K 16:9 S16	2K (2048 x 1152)	236 GB/h (Apple 4444 XQ)	04:04	08:08	120 fps	120 fps
		160 GB/h (Apple 4444)	06:00	12:01		
		109 GB/h (Apple 422 HQ)	08:46	17:32		

25.2 Sensor Related Information

Single Frame Spots of Various Shape – also known as “Digital Dust” or “White Flecks”

Natural and/or artificial radiation may cause a “false exposure” on the image sensor. The shape of these spots may vary from dots to lines or other, sometimes irregular shapes. These spots occur in random locations of the image, last only for a single frame and are more visible in dark images. This is a principle issue of all image sensors and not a malfunction.

Flicker

Some light sources (i.e. discharge tubes or LEDs) may cause an interference with sensor exposure. This may result in image flickering or “bands” of different brightness moving up or down the image. Please note that at higher frame rates (100 fps in 50Hz countries, 120 fps in 60Hz countries) even tungsten light may flicker. A short recording and playback will show this flicker.

Rolling Shutter

Due to the rolling shutter design principle of the sensor the following effects can be observed in certain situations:

- Skewed/slanted vertical lines: fast panning or fast-moving objects may result in vertical structures to appear “skewed/slanted”. The intensity of the effect depends on the relative speed of panning/object.
- Partial exposure: very short light effects (i.e. a photographer’s flash or strobe light) may result in the upper part of the image showing the light effect whereas the lower part does not or vice versa.

“Black Sun”

Very bright lights (i.e. the sun, or a photographer’s flash) may result in a black/magenta spot.

Stuck Pixels at Long Exposure Times

At longer exposure times (longer than the standard $1/50^{\text{th}}$ of a second), stuck pixels may become visible in darker image areas. The longer the exposure time the more pixels will be affected. When using exposure times longer than $1/24^{\text{th}}$ of a second, carefully check your image whether the quality meets your requirements.

25.3 Companion Tools

ARRI maintains various tools to support your work with the ALEXA 35 on- and off-set.

ARRI Reference Tool

The ARRI Reference Tool (ART) combines the functionality of the ARRIRAW Converter, ARRI Color Tool, and ARRI Meta Extract. It supports all ALEXA 35 recording formats and allows the creation of ALF4 look files, conversion to SDR and HDR color spaces with looks applied, and export to Apple ProRes, OpenEXR and TIFF files.

▶ [ARRI Reference Tool](#)

Camera Simulators

The camera simulator is an interactive learning tool to familiarize yourself with the menu navigation of ARRI digital cameras. Get started now and learn first hand the simple, straightforward menu system that only ARRI digital cameras offer.

▶ [Camera Simulators](#)

Formats and Data Rate Calculator

The ARRI Formats and Data Rate Calculator (FDRC) is an online tool that calculates the record durations and data rates for different camera settings (combinations of camera model, codec, resolution, project rate, sensor speed, recording media, audio on/off). It also gives deeper insight into available recording formats and camera modes.

▶ [Formats & Data Rate Calculator](#)

Frame Line & Lens Illumination Tool

The Frame Line & Lens Illumination Tool can be used for creating custom frame lines for ARRI cameras and for checking how different lenses illuminate different ARRI sensor sizes, recording formats, target aspect ratios and framelines.

▶ [Frame Line & Lens Illumination Tool](#)

Matte Box Checker

Use the Matte Box Checker to quickly find ARRI matte boxes that are compatible with your chosen lens and sensor mode and avoid optical vignetting.

▶ [Matte Box Checker](#)

25.4 Connector Pin-Outs

All pin-outs appear as seen by the user.

PWR (LEMO EEJ.2B.308)

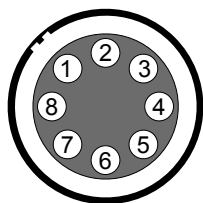

- 1 Batcom
- 2 Power GND
- 3 Power GND
- 4 Power GND
- 5 Batcom GND
- 6 Batplus
- 7 Batplus
- 8 Batplus

RS (Fischer DBP102A052-130)

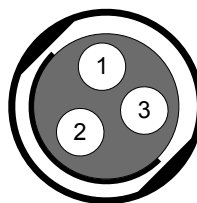

- 1 GND
- 2 24 V Aux
- 3 R/S

12V (LEMO EEG.0B.302.CLN.A365)

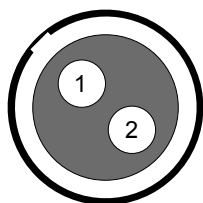

- 1 GND
- 2 12 V Aux

AUDIO (LEMO EEA.0B.306.CLN)

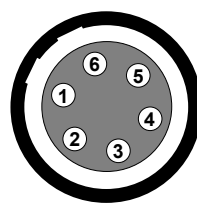

- 1 GND
- 2 CH 1 (+)
- 3 CH 1 (-)
- 4 CH 2 (+)
- 5 CH 2 (-)
- 6 12 V

TC (LEMO EEG.0B.305)

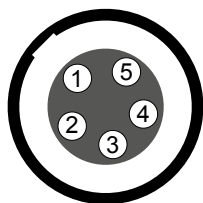

- 1 GND
- 2 LTC In
- 3 Aux
- 4 Aux
- 5 LTC Out

ETH (LEMO EEG.1B.310)

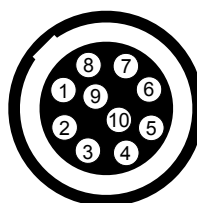

- 1 MX-1P (white-orange)
- 2 MX-1N (orange)
- 3 MX-2P (white-green)
- 4 MX-2N (green)
- 5 MX-3P (blue)
- 6 MX-3N (white-blue)
- 7 MX-4P (white-brown)
- 8 MX-4N (brown)
- 9 GND
- 10 Proprietary - do not use

LBUS (LEMO EEG.0B.304)

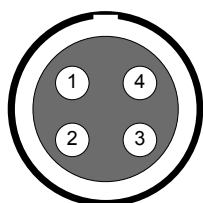

- 1 GND
- 2 Can L
- 3 VBat
- 4 Can H

SERIAL (LEMO EEC.0B.304.CLN)

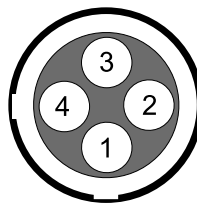

- 1 RX/B
- 2 12 V
- 3 TX/A
- 4 GND

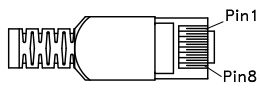
Ethernet (RJ45)

w/or	1
or	2
w/gn	3
bl	4
w/bl	5
gn	6
w/br	7
br	8

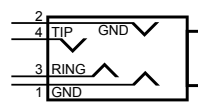
Headphones Out (on MVF-2)

1	GND
2	GND
3	R Out
4	L Out

Audio Cable K2.0023988

ARRI offers an ALEXA Mini LF / ALEXA 35 audio cable with a matching connector to create audio adapters. The following table shows the wire assignments of this cable.

Wire	Function
Black	GND
Blue	CH 1 (+)
Brown	CH 1 (-)
Yellow	CH 2 (+)
Green	CH 2 (-)
Red	12 V

25.5 Dimensional Drawings

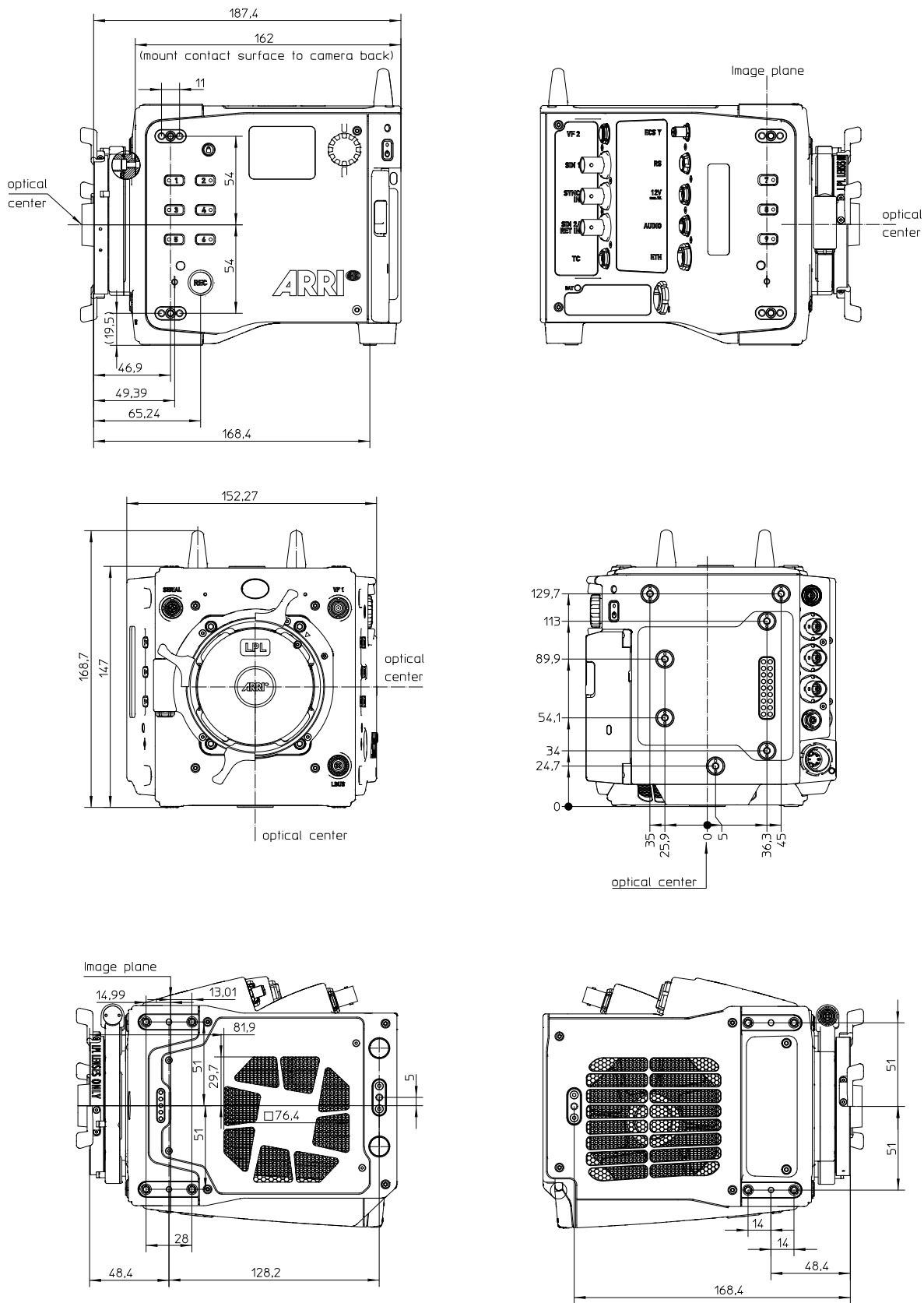

ALEXA 35 with LPL Mount (LBUS). All measurements in mm.

ALEXA 35