

ARRI®
ARRI

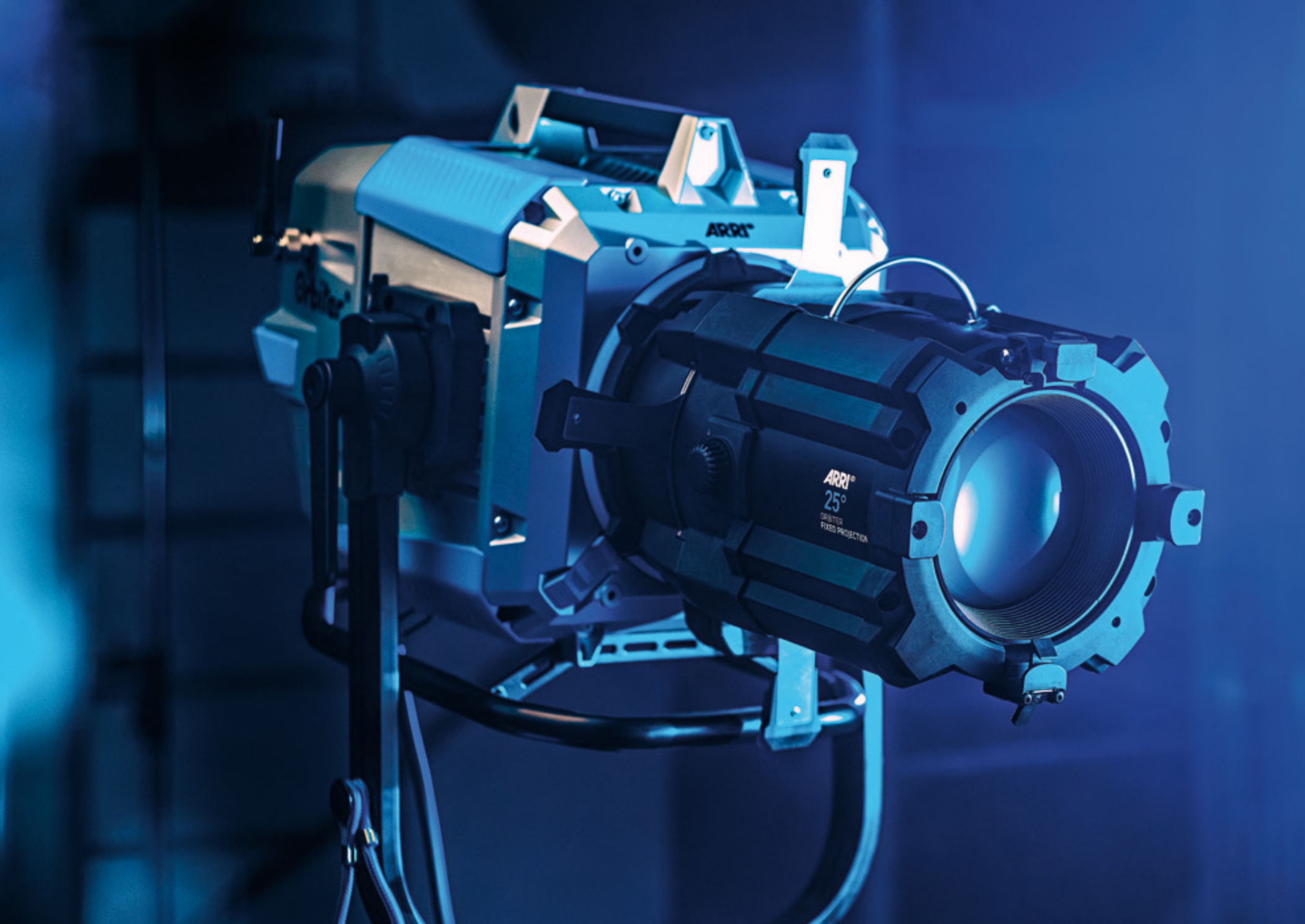

Orbiter® ARRI

ILLUMINATION | RESHAPED



What is Orbiter?

The ARRI Orbiter is a versatile, tuneable, and directional LED fixture. Orbiter's six-color light engine ARRI Spectra delivers a wide color gamut and outstanding color rendition across all color temperatures, along with industry-leading, smooth dimming from 100% to 0%. With its changeable optics, Orbiter can transform into many different types of lamphead, including Beam, Open Face, Fresnel, Projection, soft light, and many more. Orbiter's state-of-the-art technology and Lighting Operating software (LiOS) as well as its multi-functional design optimize it for today's needs as well as for emerging requirements, with endless possibilities for updates, enhancements, and new configurations.

A wide variety of changeable optics



Beam

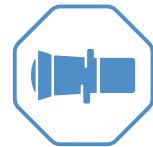

Projection



Fresnel



Open Face

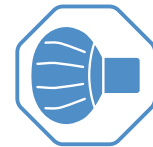

Domes

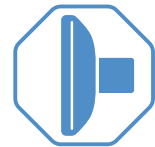

Softboxes

Changeable optics is the core innovation in Orbiter. With a wide variety of optics to choose from, Orbiter transforms into the perfect light for your application without sacrificing beam, output, or color quality. The Quick Lighting Mount (QLM) in Orbiter allows for optics with vastly different properties to be connected to the fixture. With Orbiter—you always have a choice.

QLM
Quick Lighting Mount



Your choice for different looks

Use and adapt Orbiter according to your needs



Orbiter Beam

The Orbiter Beam provides a defined and strong 4° parallel and homogenous beam of light. It is an ideal option for creating the illusion of natural light from a distance. A new optical concept, present in the reflector, allows for high intensity at full-color spectrum making the Orbiter Beam the brightest full-color LED spot light. The Orbiter Beam is perfectly suited especially within cinematic applications—either for long throw distances or indirectly bounced.



Orbiter Projection Optics

The Orbiter Projection Optics 25° and 35° provide unparalleled precision in every detail allowing for crisp projection of a light spot, as well as immaculate gobo projection and precise shutter cuts. The field of light is entirely even and without color aberration.



Orbiter Fresnel Lens 15-65°

The Fresnel Lens creates a precise light spot with a soft single shadow. It delivers true Fresnel output with a real Gaussian field of light.

The large zoom of 15-65° range is fully motorized and allows control locally or remotely. A status LED display shows the current zoom angle.



Orbiter Open Face Optics

The Open Face optics produce a high-output, directional beam of light in several different beam angles including 15°, 30°, and 60°. Perfect for throwing light long distances or providing a broad swath of light.



Orbiter Docking Ring

The Docking Ring allows various third-party optics to be mounted onto the Orbiter, giving the option for hard edge projection, focused shutter cuts and also gobo projection.



Orbiter Glass Cover

With its ultra-translucent glass, the Glass Cover allows for full, unrestricted light output without impacting color temperature or quality. It is ideal for near distance applications with limited available space where much light is needed.



Orbiter Dome Mini

The Orbiter Dome Mini provides great quality omnidirectional light at a high intensity. Compared to the Dome optic, the Dome Mini is a compact version; smaller and therefore lighter. The highly translucent material keeps the light output loss to a minimum compared to the usually larger, cloth-based domes. The light it produces is great for near distance applications with limited available space.



Domes

The Dome optics are fabric spheres available in three different diameters - small, medium and large, ranging from 30 cm (12") up to 100 cm (39") diameter. The dome emits omnidirectional light, great for illuminating a large area with a beautiful, soft quality of light.



Softboxes

The QLM in Orbiter creates a direct mounting point for dedicated Chimera and DoPchoice Softbox products. With easy attachment and no additional optical elements needed, the softboxes allow for a controlled soft light with amazing output.

Say hello to ARRI Spectra

State-of-the-art, six-color LED light engine

ARRI is known for creating high-quality lighting products. With the new ARRI Spectra light engine in Orbiter, this commitment is being taken to the next level. Including a red, green, blue, amber, cyan, and lime LED, the ARRI Spectra six-color light engine translates into a wider color gamut, more accurate colors, and most importantly, higher color rendition across the entire CCT range. Skin tones look amazing and natural. Hues are precisely reproduced and the increased gamut allows for 15% more colors to be created than previous ARRI light engines. Orbiter has a larger CCT range of 2,000 to 20,000 K with ultra-high color rendition across all color temperatures. This next generation in color control will open up new possibilities and produce better colors than ever before.

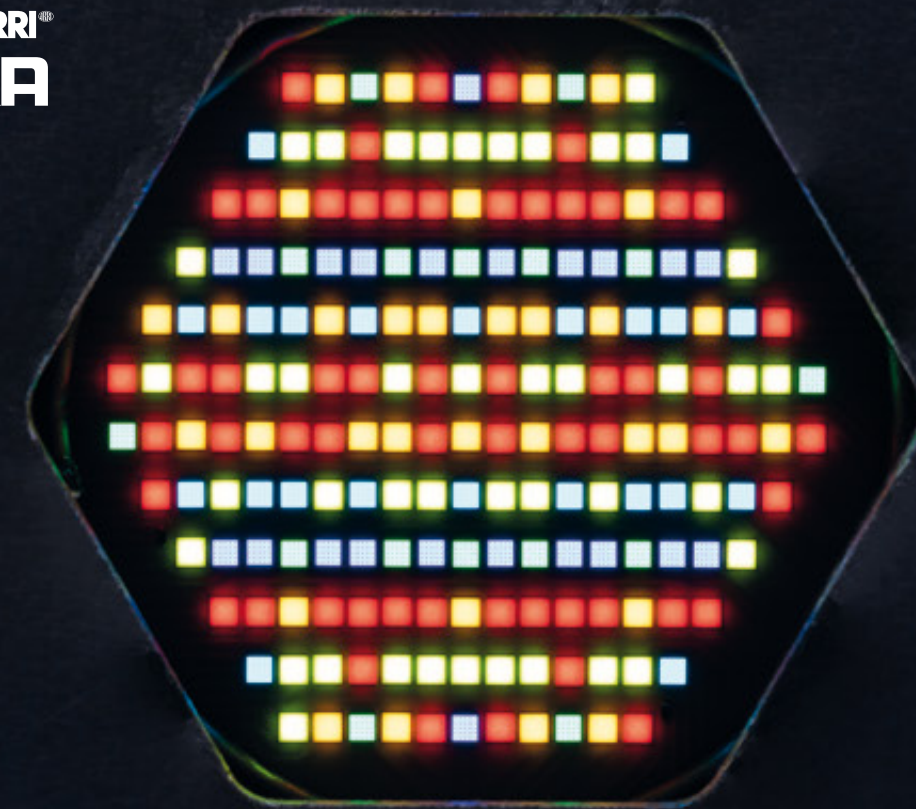

Sheer output

Immense brightness with full-color tunability

Orbiter is an extremely bright directional LED fixture with an output similar to corresponding HMI systems. Orbiter's powerful yet tuneable ARRI Spectra light engine provides outstanding color quality and brightness, rendering hard shadows with defined edges. Overall, Orbiter creates great highlights, natural skin tones, and crisp shadows. This revolutionary light engine is 76 times smaller than the L10's light engine but produces greater output while drawing the same amount of power. Orbiter's light engine consists of over 200 advanced LEDs, arranged in a point source-like aperture, which produce stunning light output while maintaining color quality and full-color tunability. The compact light engine uses a six-color LED mixture to create a homogeneous color beam field with brightness levels that easily rival much larger lighting fixtures.



Technology unleashed

Fast, powerful, and full of possibilities

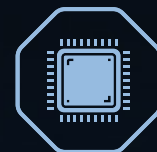

Electronics

With state-of-the-art electronics, Orbiter is able to perform more tasks than previous luminaires. Orbiter's processor is four times faster than the SkyPanel with 125 times more memory, setting the stage for extensive software features and updates in the future.



Battery

Orbiter includes a lightweight internal power supply and a 3-pin XLR battery input for 48 V_{DC} batteries.



Dimming

Using a combination of three dimming techniques, Orbiter's cutting-edge electronics provide smooth dimming down to zero without color changes or jumps.





Integrated color sensor

Reproduces ambient light in seconds

The new Color Sensor Mode in Orbiter will read the ambient color surrounding the fixture and reproduce the color with great accuracy. There are two measurement types: continuous and momentary. Continuous will constantly measure the ambient color and update the light output accordingly. Momentary will only take one measurement of the ambient color with the press of a button. This new color mode is perfect in situations where the light is changing. Orbiter can automatically adjust for color changes without any interaction.

Full suite of sensors

Generating more information for more control

A digital light of the future requires data. Orbiter is aware of the world around it with a variety of sensors that allow for advanced operations, smart automations, and a stream of metadata. Included in Orbiter is a color sensor for measuring the ambient light, a 3-axis accelerometer and magnetometer for sensing the pan, tilt, roll, and heading of the fixture as well as heat sensors for keeping the LEDs and electronics at exactly the right temperature, and an ambient light sensor for automatically dimming the control panel display. All these sensors make for a better user experience and increased control over the fixture. Available data improve workflow also in post production and service.



LiOS - powerful software

Packed with amazing features

The software powering Orbiter is called LiOS (Lighting Operating System). It amalgamates and expands on the innovative and groundbreaking features of the SkyPanel series, making Orbiter one of the most fully featured luminaires on the market. LiOS offers eight color modes: CCT, HSI, individual color, x/y coordinates, gel, source matching, lighting effects, and the color sensor mode, which measures ambient light and recreates it through Orbiter's output. Other LiOS features include simplified DMX modes, Sync Mode, that triggers the light output when and how the camera needs it, Cue Mode, which allows for fluid and easy light changes in different lighting modes, storage for hundreds of favorite settings, optics recognition, multi-language support, custom boot screen, and many more yet to come.



LIOS
Lighting Operating System

Removable control panel

Handheld light control

Including a 4" full-color display, quick navigation buttons, and integrated sensors, the Orbiter control panel allows for easy use with a graphic user interface. Simplified menu structure and reimagined user interfaces provide one-glance operational views and uncluttered screens. This intuitive design makes changing colors or finding a setting easier than ever before while still maintaining the powerful features Orbiter has to offer. In addition, the control panel is removable and can be used handheld with the aid of a 5 or 15 m (16.4 or 49.2 ft) control panel cable.

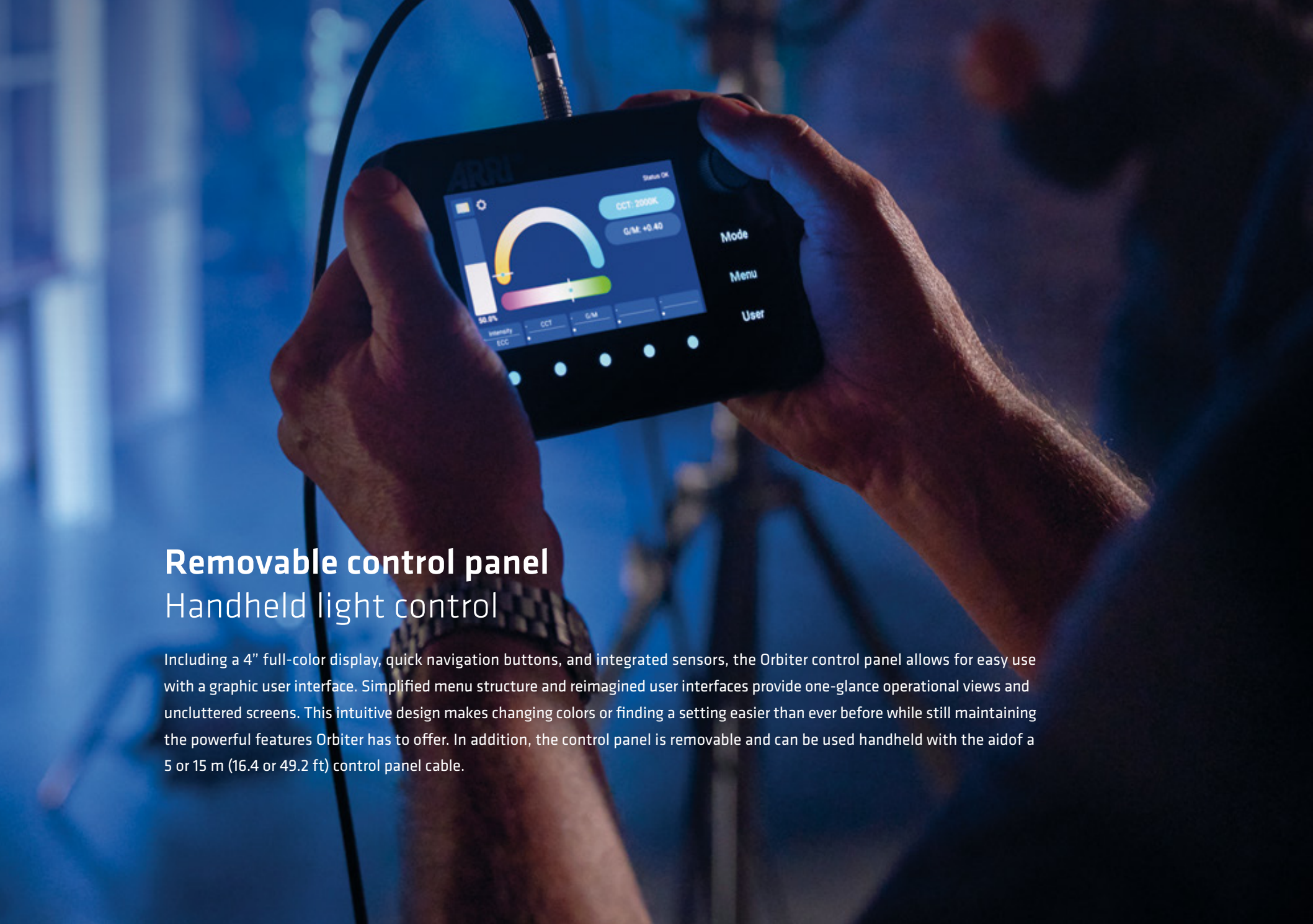

Connectivity

Ready for today, prepared for tomorrow

Communication to and from a luminaire is crucial to create robust networks and dynamic control. Orbiter includes a full suite of input and output connectors which enable communication to the fixture in whatever way is required. With all these connectivity interfaces, Orbiter is not only ready for today's state-of-the-art communication but is also prepared for whatever the future might bring.



Motion Picture

Orbiter's amazing output and versatility makes it the perfect directional light fixture for motion picture use. The ability to throw light long distances with open face or projection optics while at the same time being able to serve as a soft light brings the flexibility needed on today's fast paced film sets. Given its sleek ergonomics and intuitive user interface, the control panel enables easy handling and control of the luminaire on the fly. The software features and connectivity make Orbiter the ultimate companion for dynamic lighting setups.



Broadcast & Media

Broadcasters now have a tool to illuminate their studios and on-location setups. Orbiter's projection optic enables broadcasters to have controlled, high-quality light in the studio. In combination with the SkyPanel, Orbiter is the perfect companion to studio lighting. The open face optic or softbox option provides either tremendous directional output or a soft wrapping field of light. With its battery power, Orbiter can easily be used on the move. Further, the ARRI Solutions provides turnkey lighting solutions for tomorrow's production infrastructures. One of the solutions is ARRI LightNet which has been developed as a powerful, visually intuitive, and flexible tool to assist the smooth and efficient operation of contemporary studio facilities with both IP-based and DMX-controlled lighting systems.





Theater & Live Entertainment

The projection optic is the key feature for the theater and live entertainment market. With incredible output that is significantly brighter than comparable products. The pristine beam quality creates a precise circle of light that can be shaped with gobos, cutters, and an iris. The ARRI Spectra light engine generates superior white light and a vast amount of saturated or merely tinted colors.



Photography

The need for continuous lighting in photography has never been greater and Orbiter fills a critical function in this workflow transition. With Orbiter's directional source, hard shadows are now attainable with countless color possibilities. Whether bouncing off a surface or pointed directly at the subject, Orbiter will give the output needed with beautiful color rendition. Octagonally shaped softboxes convert the point light source into a great soft light perfect for beauty shots, changing the light characteristics in just seconds.

Orbiter for virtual production

Simulation of natural light

Orbiter—the ideal light for virtual production stages. The high-quality LED point light source provides perfect illumination of talent and perimeter, delivering natural skin tones and authentic color reproduction. Further, high-contrast lighting creates more depth for a fully immersive experience. All made possible through Orbiter's core innovation: changeable optics. And lastly, IP-based lighting data networks offer bi-directional communication with playback systems, allowing light and color to be synced with the volume imagery.



Built to last

Constructed with great care from durable materials

Made in Germany to the high standards for which all ARRI products are known, Orbiter is built to last – constructed from resilient materials and assembled by hand with great care. The combination of an aluminum core with fiberglass-reinforced thermoplastics results in a solid fixture that can withstand heavy daily use. The electronics have been designed to last beyond a minimum of 50.000 hours, and to be easily serviceable. The LED light engine even allows for recalibration, further enhancing Orbiter's credentials as a long-lasting, high-quality fixture. As with all ARRI products, a high return on investment is ensured by uncompromising engineering standards.

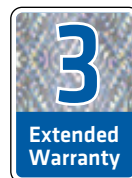

ARRI offers a three-year extended warranty for its LED fixtures, which is included in the purchase price without any extra costs or further application process. LED accessories are not included.

Weatherproof

Fully protected with the Rain Cover

Orbiter's housing is weatherproof. To ensure no defects, Orbiter's ports (such as power, or XLR (for DMX)) require additional protection. The Rain Cover guarantees an IP24 rating and is mandatory when the Orbiter is tilted at a horizontal angle or facing downward and recommended from 0° to 75° upwards. Orbiter without Rain Cover are rated IP20.



Technical Data

Optical System	Changeable optics
Light Aperture	42 mm / 1,66", without optics
Beam Angle	80° Half Peak Angle, without optics
Weight	Fixture only: 11,7 kg / 25.8 lbs Manual Version: 14,2 kg / 31.3 lbs Pole Op Version: 14,9 kg / 32.9 lbs
Handling	Aluminum yoke with quick release, high strength tilt lock, pole operation option (pan and tilt)
Mounting	28 mm Spigot (Junior Pin)
Tilt Angle	+/- 90° in dry location, +75° / -90° in wet location with rain cover
Power Consumption	400 W Nominal, 500 W Maximum
Voltage Input Range	100 - 240 V~, 50 - 60 Hz
Mains Power Connection	powerCON TRUE1 TOP (Bare Ends / Schuko / Edison, Japanese, Chinese cables available)
DC Voltage Range	48 - 52 V _{DC}
Battery Connector	3-Pin XLR Connector (Pin 1: negative, Pin 2: positive)
White Light	calibrated 2,000 K to 20,000 K continuously variable correlated color temperature
Color Modes	CCT, HSI, RGBACL, x/y coordinates, gel selection, source matching & color sensor plus: extended color control (ECC) for individual finetuning
Color Temperature Tolerance	3.200 to 5.600 K: +/- 100 K (nominal), +/- 1/8 Green-Magenta (nominal)
High Color Rendition Mode	3.200 to 5.600 K: CRI Average > 98 TLCI Average > 95 TM-30 Average > 94
Green-Magenta Adjustment	Continuously adjustable between full minus-green to full plusgreen
Dimming	Smooth, 100 to 0 %, continuously, linear / exponential / logarithmic / "S" curve
Connectivity	Removable Control Panel via PoE, 5-Pin XLR in and through, EtherCON in and through, 2 x USB-A, USB-C, SD Card, sync input
Control Options	DMX 512 (8 & 16 bit), RDM E1.20, wireless control via LumenRadio CRMX1 (DMX & RDM), Art-Net, sACN, removable Control Panel, integrated webportal
Housing Color	Blue/silver, black
Ambient Temperature Operation	-20 to +45° C (-4 to +113° F)
Protection Class	I
IP Rating	IP 20 without Rain Cover, IP 24 with Rain Cover L2.0037805
Estimated LED Lifetime (L70)	50,000 hours
Estimated Color Shift Over Lifetime (CCT)	+/- 5 %
Declaration of conformity & Certifications	CB, CE, UKCA, ENEC, cNRTLus, ICES, FCC, PSE, MIC, KC, SRRC, RCM, IFT, TRA, ETA, ANATEL, ENACOM, NTC

All specifications are typical values. Subject to change without notice.

*Brand: LumenRadio AB, Equipment: CRMX TIMo, Model: 200-1502, Product: Orbiter 2.4G Wireless Control Module, Frequency Range: 2402 - 2480 MHz, Frequency of Operation: 2402 - 2480 MHz, Power Output: 17.51 dBm, Number of Channels: 79, Channel Spacing: 1 MHz, Modulation Type: GFSK

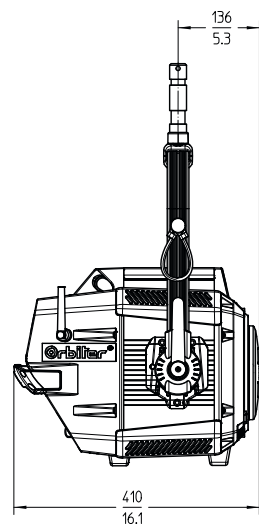
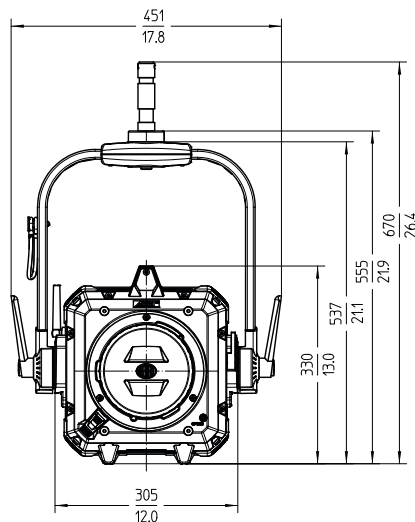

User Feedback



"After testing the Orbiter with almost every attachment, I'm sure that this fixture will change my way of shooting. Its new Quick Lighting Mount saves an enormous amount of time, making the lamphead's versatility even more valuable. And because of ARRI's top-quality construction, Orbiter will last for a long time. In combination with the SkyPanel family, the Orbiter will become a new workhorse for me."

Andy Stein, gaffer & rental house owner, Germany



"Orbiter's optical system and color versatility are a groundbreaking combination. The color science renders natural-looking skin tones in tungsten or daylight, along with an endless array of variable colors. The optical system gives me the choice of a focusable direct beam, indirect bounce source, or diffused lighting from the same fixture. Orbiter provides fast, efficient lighting options in an industry where every second counts."

Cory Geryak, cinematographer, US



"Orbiter has a very impressive new function: the color sensor. It can tell you the overall color temperature on set and adjust itself to the right color temperature to make the lighting look harmonious. This is definitely a great help, since it's all about efficiency nowadays. Also, the wireless DMX can control color temperature, brightness, and special lighting effects, which saves lots of time adjusting lights and gives you time to create better shots."

Jimmy Huang, gaffer, China



ARRI YouTube Channel

TECH TALKs, filmmaker interviews, and more

To help keep you inspired, ARRI populates its YouTube channel with a wide range of educational, behind-the-scenes, and creative video content. Whether it's a tech talk on a specific Orbiter accessory, an interview with a cinematographer or gaffer about their choice of lighting at a film set, our Orbiter playlists will keep you up to date on the latest news around Orbiter.

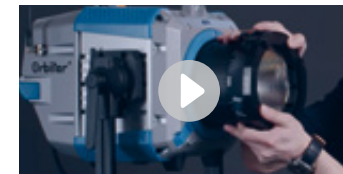

ARRI TECH TALKs

The ARRI TECH TALK series covers a broad spectrum of different topics, including technical deep dives, equipment tutorials, and discussions with industry professionals. The playlist is an ever-growing library of previous talks.

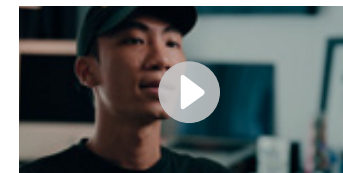

Filmmaker interviews

ARRI's working relationships with filmmakers can span their entire careers. Often, they are kind enough to sit down with us and discuss their latest project, their creative approach, or their experiences with our equipment. The playlist is crammed with tips and insights from top DPs, lighting designers and gaffers.

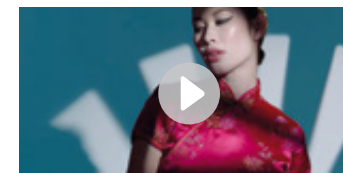

Application possibilities

Get inspiration on your different application possibilities hence the wide variety of optics to choose from and the many other features Orbiter offers you.



Global service and support For an international industry

ARRI products are renowned all over the world for their precision and durability. Despite this, ARRI values the trust of its customers in after-sales service and support as highly as their trust in the equipment itself. With service centers covering the entire globe, we are never too far away to provide the support you need, wherever you might be.

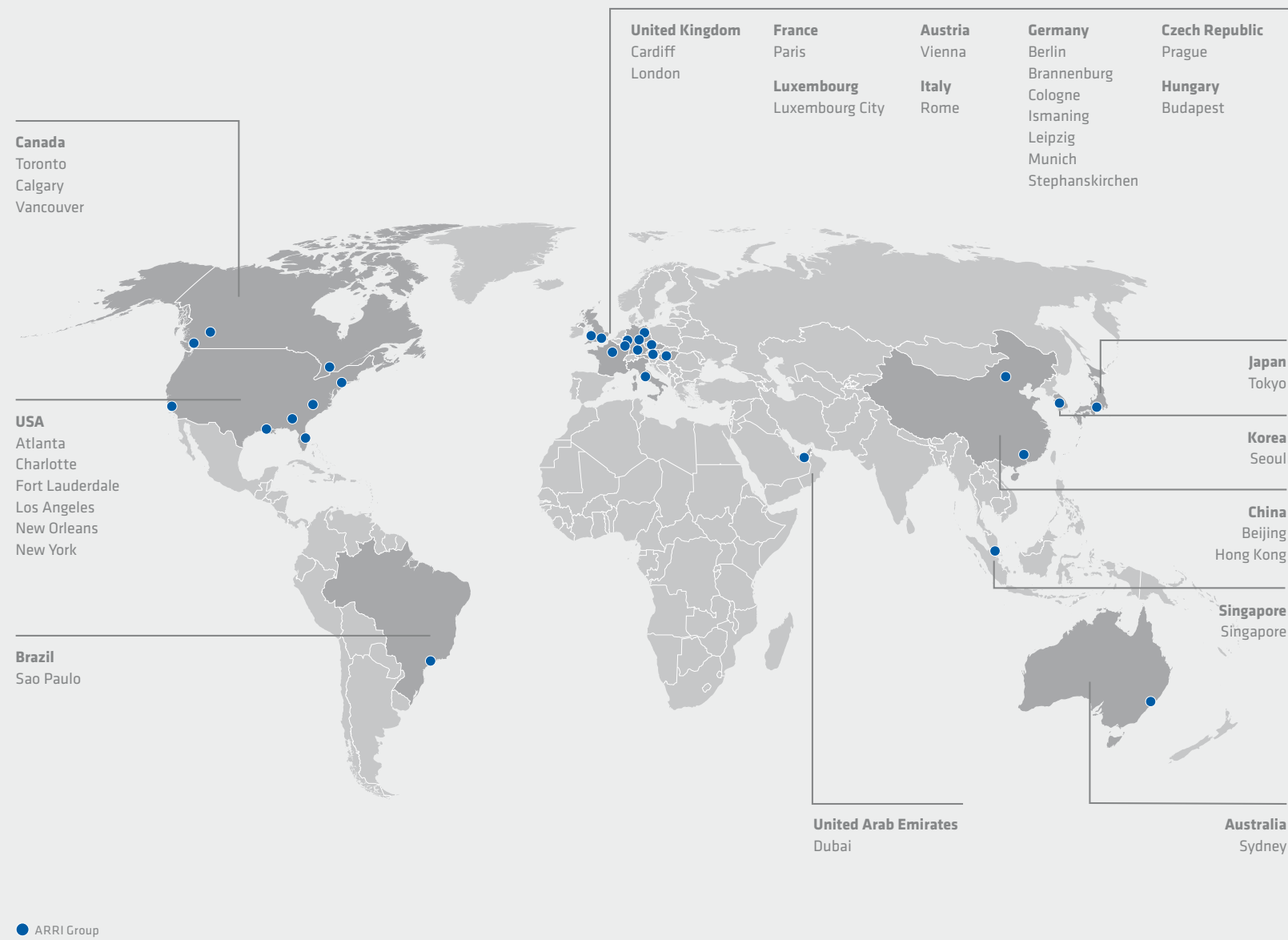

This Orbiter brochure (80.0033512 / L04142) is published by Arnold & Richter Cine Technik, February 2024 © ARRI/2024. Technical data and offering are subject to change without notice. All rights reserved. Without any warranty. Not binding 02/2024. ARRI, the ARRI logo, **UOS**, Orbiter, Quick Lighting Mount, QLM, SkyPanel, SKYPANEL, and Stellar as well as the blue/silver color combination are registered trademarks of Arnold & Richter Cine Technik GmbH & Co. Betriebs KG.



www.arri.com/orbiter